

FLEXIBLE, NON-METALLIC COVERING

Arma-Chek[®] R

Industrial Application Guide
Applications -50°C to 125°C (-58°F to 257°F)

www.armacell.com/energy



 **armacell**[®]
Arma-Chek[®]



Contents

CONTENTS

04

APPLICATION DETAILS

- 04 Scope
- 04 Contact temperature range
- 04 Operating temperatures
- 05 Operating temperatures from -50°C to +125°C (-58°F to 257°F)
- 05 Operating temperatures < -50°C (-58°F)
- 06 Operating temperatures from 126°C to 250°C (259°F to 482°F)
- 06 Products
- 07 Equipment/tools
- 08 Technical support
- 08 Application conditions
- 09 Waiting times & curing conditions
- 10 Changes in ambient temperature
- 10 Surface preparation/cleaning
- 11 Adhesive selection
- 11 Applying adhesive
 - Partial adhesive coverage
 - All-over adhesive coverage
- 14 Adhesive coverage
- 15 Direction of application
- 15 Staggered and overlapped joints
- 17 Arma-Chek Mastic
 - Application of mastic beads
 - Continuation/termination of mastic beads
 - Finishing of mastic beads
- 22 Standard application method Arma-Chek R
- 23 Terminations pipe/vessel surface temperatures between -50°C (-58°F) & 100°C (212°F)
- 25 Terminations pipe/vessel surface temperatures above 100°C (212°F)
- 26 Valve/flange boxes & terminations
- 26 Penetrations
- 27 Pipe supports/cradles
- 28 Fabrication of fittings
 - Fabrication example: elbow: segmented bend
 - Fabrication example: elbow: mitred elbow
 - Fabrication example: T piece: equal T piece
 - Fabrication example: T piece: unequal T piece
 - Fabrication example: Reducer
- 50 Non-removable, non-metallic enclosures (Arma-Chek R)
- 52 Application of Arma-Chek R over other materials
- 53 Inspection checklist

Scope

This manual describes the standard methods for application of Arma-Chek R to vessels and industrial process pipework, with operating temperatures from -50°C to $+125^{\circ}\text{C}$ (-58°F to 257°F).

Arma-Chek R flexible, non-metallic covering is normally installed as the final layer of the insulation system to provide weathering and mechanical protection.

Instructions for the application of ArmaFlex and ARMA-CHEK components are given in the ArmaFlex and ARMA-CHEK Application Guides.

Contact Temperature Range

CONTACT TEMPERATURE RANGE FOR ARMA-CHEK R

Arma-Chek R shall only be applied to surfaces with a contact temperature between -50°C to $+100^{\circ}\text{C}$ (-58°F to 212°F). Arma-Chek R may be used for systems with higher/lower operating temperatures provided it is installed in accordance with our recommendations (eg used with metal end caps).

**-50°C to $+100^{\circ}\text{C}$
(-58°F to 212°F)
direct contact with
Arma-Chek R**

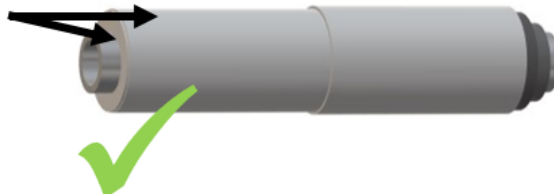

For additional advice contact Energy Technical Services
www.armacell.com/energy or email technical.oilandgas@armacell.com

Operating Temperatures

OPERATING TEMPERATURES FROM -50°C TO +125°C (-58°F TO 257°F)

Arma-Chek R may be applied to ArmaFlex insulation which is installed on pipes/vessels with an operating temperature between -50°C to +125°C (58°F to +257°F).

See termination section of this document for explanation of how to apply Arma-Chek R when contact surface temperatures exceed 100°C (212°F).

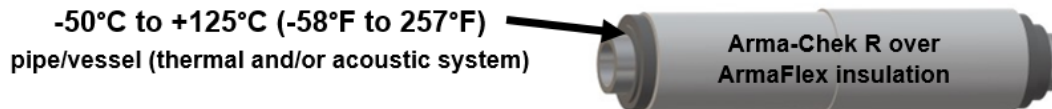

OPERATING TEMPERATURES < -50°C (-58°F)

For operating temperatures < -50°C (-58°F), rigid cold/cryogenic insulation shall be applied between the pipe/vessel and the ArmaFlex insulation.

The interface temperature between the rigid insulation and LT/ArmaFlex Industrial or HT/ArmaFlex Industrial shall not be < -50°C (-58°F).

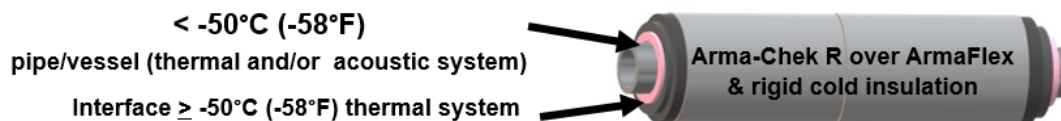

Where ArmaFlex Ultima is to be considered for use as the thermal layer < 50°C (-58°F) please consult Armacell Energy.

Arma-Chek R shall not be allowed to be directly in contact with surface temperatures < -50°C (-58°F).

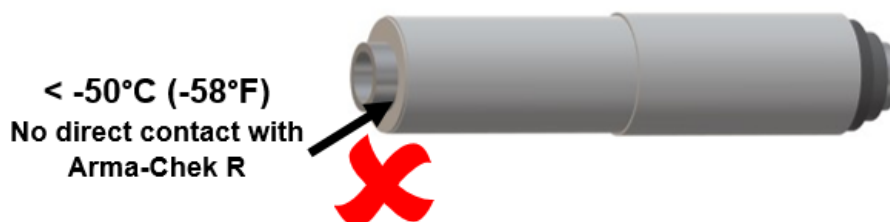

OPERATING TEMPERATURES FROM 126 TO 250°C (259 TO 482°F)

For pipework/vessels with operating temperatures > +125°C, other types of high-temperature insulation such as ArmaGel HT may be used as first layer(s) of the insulation system. This is in order to limit the exposure temperature of the overlaying ArmaFlex/ArmaSound insulation system components.

126 to 250°C (259 to 482°F)
 pipe/vessel (thermal and/or acoustic system)



Pipe/vessel operating temperature limits

The configuration and thickness of insulation layers shall ensure that their maximum service temperatures are not exceeded.

In no case shall Arma-Chek R be applied on systems with operating temperature > +250°C.

Arma-Chek R shall not be allowed to be directly in contact with surface temperatures > 100°C (212°F).

> 100°C 212°F)
 No direct contact with Arma-Chek R

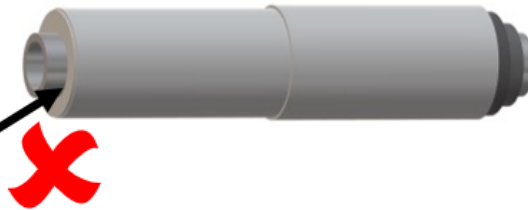

Products

- Arma-Chek R
- ArmaFlex Adhesive HT 625
- ArmaFlex Adhesive 520
- Arma-Chek Mastic



Data sheets available at: www.armacell.com/energy

Arma-Chek R of thickness 1mm (0.04 in.) shall only be used for thermal applications with operating temperatures > -50°C (-58°F).

Arma-Chek R of thickness 2mm (0.08 in.) is used for ArmaSound acoustic applications or in areas where greater mechanical protection is required.

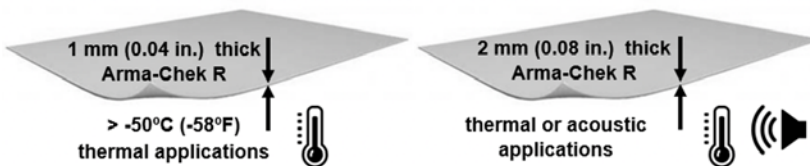

Use appropriate thickness of Arma-Chek R

Equipment / Tools



- Knife example:
 - Craft knife
 - Retractable Craft knife
- Scissors
- Marker pen
- Square
- Dividers
- Mastic gun
- Ruler / tape measure
- Glue brushes / Glue Master dispenser
- Glue roller / tray
- Glue spreader
- Straight edge
- 40-50mm wide heavy roller for overlaps

Technical Support

Contact the Energy, Technical-Services Team at www.Armacell.com/energy or email technical.oilandgas@armacell.com for advice, and guidance for non-standard applications and application support/training.

Application Conditions

Apply only when conditions are suitable. If conditions cannot be controlled, consult Armacell Energy for advice.



air temp.
5°C to 35°C
(41°F to 95°F)



surface temp.
5°C to 35°C
(41°F to 95°F)



humidity
< 80% RH.
3°C (5°F)
> dewpoint



shade



shelter
from rain

Waiting Times and Curing Conditions

Depending on fixing method, allow between 3-24 hours adhesive curing time for ArmaFlex and ArmaSound systems before applying Arma-Chek R. Shelter from adverse weather during adhesive curing time, but do not seal tightly in polythene or other covering.

It is recommended that Arma-Chek R be applied within 5 days to protect the Arma-Flex/ArmaSound system.

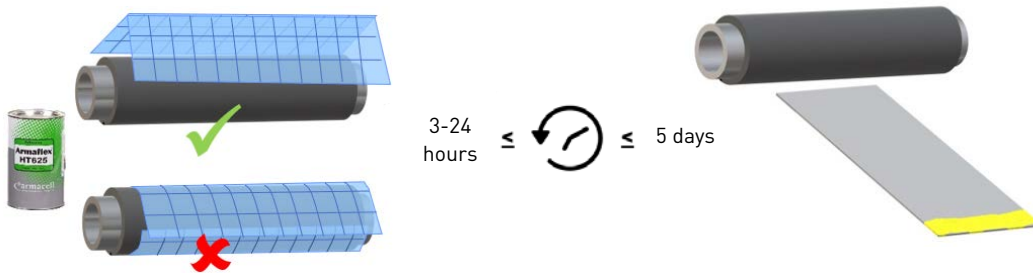

Temperature shall not exceed 35°C for first 6-8 hours of adhesive curing unless otherwise approved by Armacell Energy.

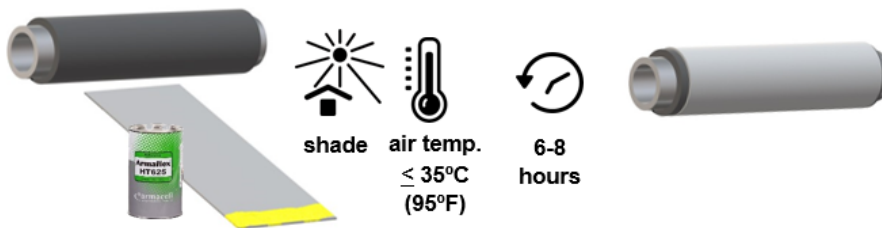

Do not cover Arma-Chek Mastic beads while curing; protect from dust/dirt.

To reduce the risk of mould/damage, do not tightly wrap an Arma-Chek installation for extended periods.

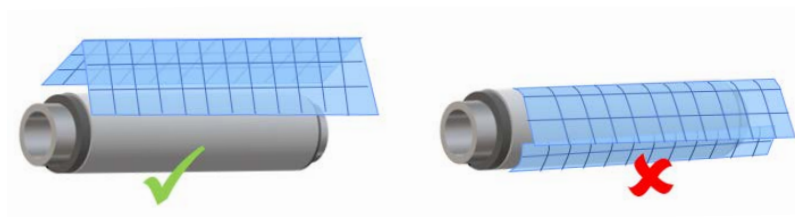

Changes in Ambient Temperature

Arma-Chek R's flexibility allows for the thermal expansion of ArmaFlex insulation. As temperatures decrease, Arma-Chek R will contract at a different rate from ArmaFlex insulation which may cause harmless visual changes. This will not affect the integrity of the system and will be less apparent when using 2mm Arma-Chek R and all-over adhesive application. If temperatures could change by more than 40°C (72°F) please contact Energy Technical Services for advice www.armacell.com/energy or email technical.oilandgas@armacell.com

Surface Preparation / Cleaning

The pipe surface or underlying insulation surface must be clean, dry and free from rust, oil, contamination or damage. ArmaFlex Cleaner may be used (subject to client approval) on the pipe using a clean white cotton cloth on the pipe to assist in oil/grease removal. Only use ArmaFlex Cleaner on the ArmaFlex surface with caution, and allow at least 10 minutes for solvent evaporation before subsequently applying adhesive or mastic.

If any dust is present on any of the ArmaFlex, ArmaSound or Arma-Chek R components, it shall be removed prior to application of adhesive using a dry cloth or soft brush.



It is essential to use ArmaFlex Cleaner to remove the Arma-Chek R release-agent coating and any adhesive residue from the Arma-Chek R surface before applying Arma-Chek Mastic.

Do not use alternative cleaners since they may cause a weakening of the mastic bond.

Allow 4 hours adhesive curing time before using ArmaFlex Cleaner close to adhered joints.

1 litre (1 US quart) of ArmaFlex Cleaner is sufficient to clean the joints present on 50 m² (538 ft²) of installed Arma-Chek R.



Clean surface of Arma-Chek R before applying Arma-Chek Mastic

ArmaFlex Cleaner shall not be used to clean the surface of Arma-Chek Mastic before or after curing.

Do not clean finished applications until mastic is completely 100% fully cured. Use water and a general cleaning agent and wait a minimum of 72 hours after application in high-temperature/high-humidity conditions, or 7-9 days in low-temperature/low-humidity conditions.



ArmaFlex Adhesive Waiting Times

ArmaFlex Adhesive Waiting Time (During Installation of Single & Multi-layering Materials & Cladding)				
ArmaFlex / ArmaSound RD 240		Arma-Chek R / Acoustic Barrier / Other Impermeable Materials & Rigid Claddings		Arma-Chek Mastic
Adhesive Method:	NEW Wait Time: (Between Layers)	Adhesive Method:	NEW Wait Time: (Between Layers)	NEW Wait Time: (Between Layers)
Seams & Wet Seal Joints (All Layers) Standard Installation	1 Hour	Overlaps Only	3 Hours	4 Hours
Seams & Wet Seal Joints Including (Partial ¼ - ⅓) Adhesive Fixing	12 Hours or 1 Hour Using D-Tape Method	Overlaps Including (Partial ¼ - ⅓) Adhesive Fixing	24 Hours	4 Hours
Seams & Wet Seal joints Including (All Over Adhesive) Fixing	12 Hours or 1 Hour Using D-Tape Method	Overlaps Including (All Over Adhesive) Fixing	24 Hours	4 Hours

ArmaFlex Adhesive Waiting Times before next ArmaFlex layer, Arma-Chek R, Acoustic Barrier or Arma-Chek Mastic is applied

Adhesive Selection

Use the correct adhesive: ArmaFlex HT625 adhesive may be used with all ArmaFlex/Arma-Chek types, but ArmaFlex 520 adhesive may only be used with LT/ArmaFlex Industrial.

ArmaFlex HT625 Adhesive



- ✓ Arma-Chek R
- ✓ LT/ArmaFlex Industrial
- ✓ HT/ArmaFlex Industrial
- ✓ HT/ArmaFlex Industrial IMO
- ✓ Arma-Chek RD240
- ✓ Arma-Chek Barrier

ArmaFlex 520 Adhesive



- ✓ Arma-Chek R
- ✓ LT/ArmaFlex Industrial
- ✗ HT/ArmaFlex Industrial
- ✗ HT/ArmaFlex Industrial IMO
- ✓ Arma-Chek RD240
- ✓ Arma-Chek Barrier

Applying Adhesive

To adhere Arma-Chek R to Arma-Chek R or another surface, brush or roll a thin, even, film of ArmaFlex Adhesive to both contacting surfaces. Allow the adhesive to become 'tack-dry' then apply firm and even pressure to the Arma-Chek R component surface(s). The term 'tack-dry' means that adhesive is sufficiently dry that it will not stick to a finger nail or glove when touched.

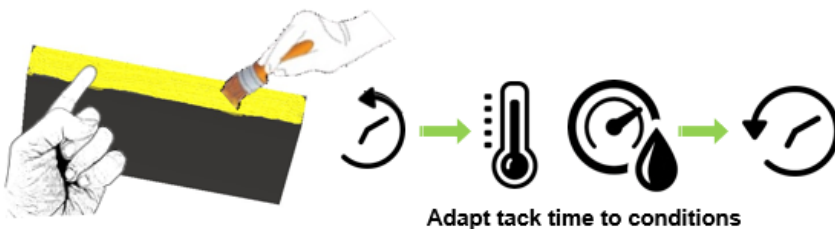

The time taken for the adhesive to become tack dry will depend on the ambient temperature and humidity.

The 'open time' time during which a bond can be made is also limited by temperature and humidity. These time periods must be adapted as weather conditions change.

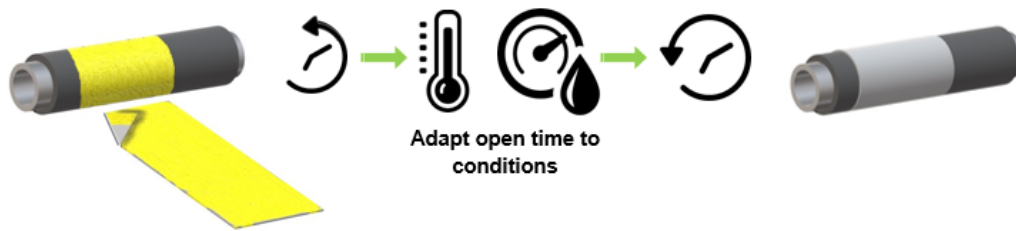

Applying Adhesive

PARTIAL ADHESIVE COVERAGE

The term 'partial adhesive coverage' is defined as the application of 100% adhesive fixing for a specified limited contact area. Spot adhesion is not permitted.

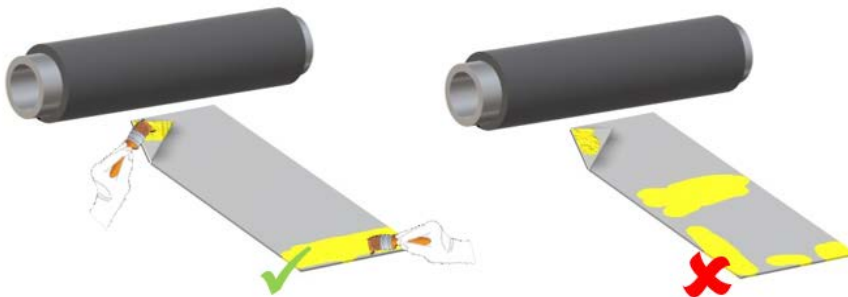

Applying Adhesive

ALL-OVER ADHESIVE COVERAGE

The term "all-over adhesive" coverage is defined as the application of 100% adhesive coverage over both contact surfaces where the sheet/tube is glued to the object or previous layer with its entire surface. Spot adhesion is not permitted.

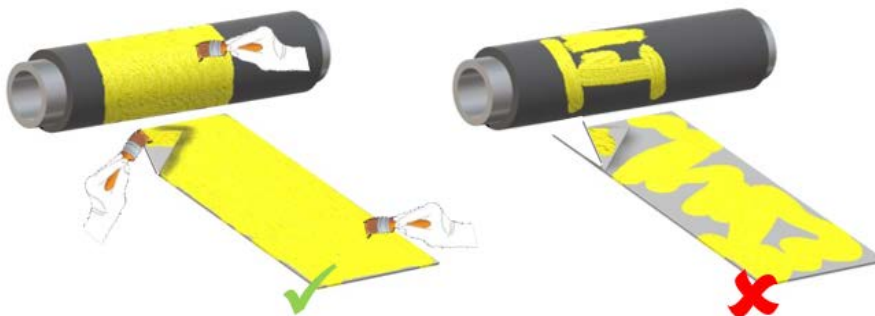

Adhesive Coverage

1 litre (1 US quart) of ArmaFlex Adhesive 520 or HT625 will cover between 3 and 8m² (32 to 86 ft²) of surface, depending on the type of surface.

	Adhesive coverage - m ² / litre [ft ² / quart]	
	Brush/gluemaster	Roller/spreader
ArmaFlex / substrate	6-8 (65-86)	4-6 (43-65)
ArmaSound RD240	4-6 (43-65)	3-4 (32-43)
ArmaSound Barrier	5-7 (54-75)	4-6 (43-65)
Arma-Chek R	4-6 (43-65)	3-5 (32-54)

Note that these coverage rates are for each surface covered, for example:

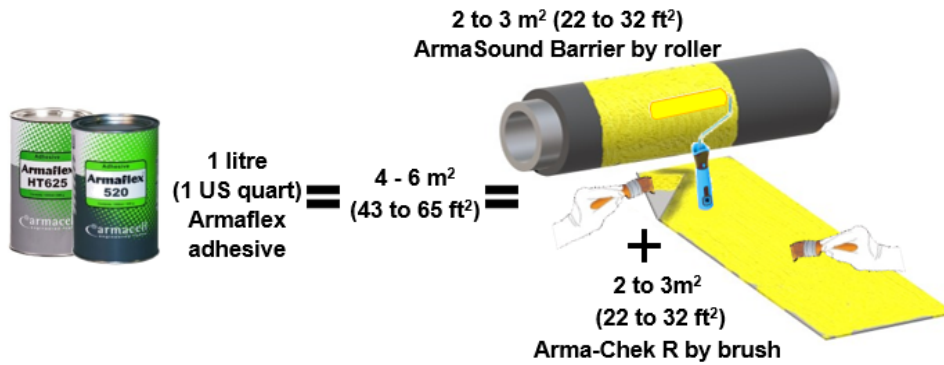

Direction of Application

When applying Arma-Chek R sheet, ensure that the natural curvature of the rolled sheet follows the curvature of the pipe.

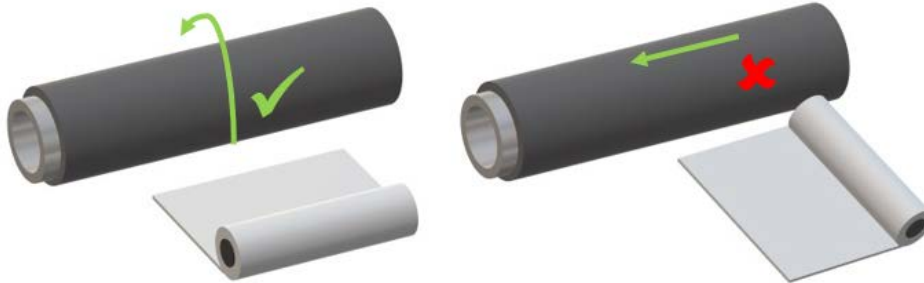

Arma-Chek R sheet shall follow natural curvature of pipe

Be sure not to trap adhesive solvent vapours or air as bubbles between the Arma-Chek R and underlying surface.

Staggered and Overlapped Joints

All Arma-Chek R joints shall be overlapped and staggered by a minimum 50mm (2 in.) and secured firmly with ArmaFlex Adhesive. The quantity of joints shall be minimised.

Longitudinal joints shall be positioned to the side to shed water. All overlapping joints shall be positioned to shed water. All Arma-Chek R joints shall additionally be sealed with Arma-Chek Mastic.

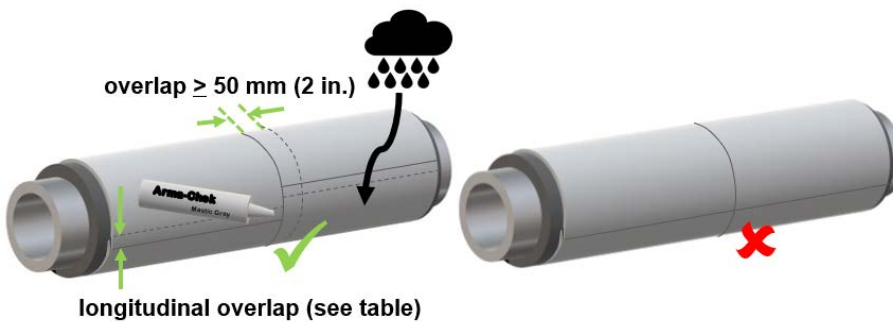

For applications to horizontal piping between pipe diameters up to 20 in. nominal bore (NB) the dimension of the longitudinal joint overlap shall be increased as the pipe diameter increases, according to the table below.

Minimum required longitudinal overlap of Arma-Chek R joints	
Pipe Size	Minimum overlap [mm]
Horizontal Piping ≤ 5" NB	50 (2 in.)
Horizontal Piping 6" to 8" NB	75 (3 in.)
Horizontal Piping 9" to 16" NB	100 (4 in.)
Horizontal Piping 18" to 20" NB	125 (5 in.)
Horizontal or vertical piping with all-over adhesive coverage	50 (2 in.)

Vessels, larger horizontal piping over 72" NB*, and all diameters of vertical piping shall be fully adhered to the underlying surface and so only require a 50 mm (2 in.) joint overlap.

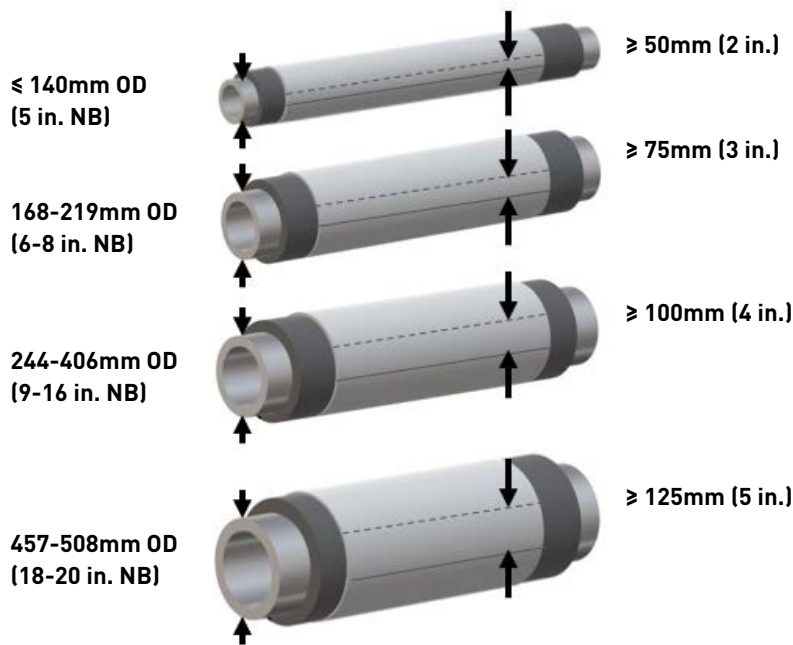

Arma-Chek R joint overlaps for horizontal piping

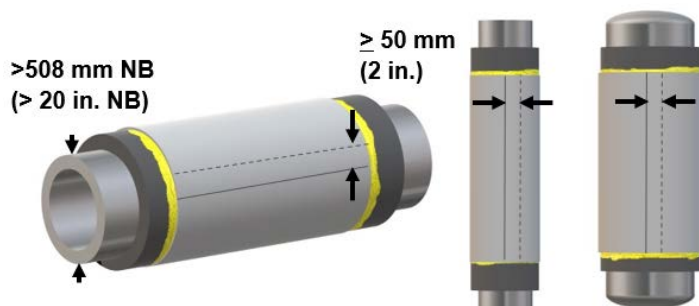

Arma-Chek R 50 mm (2 in.) joint overlaps for all-over adhesive application

Arma-Chek Mastic

GENERAL INFORMATION

Arma-Chek R Mastic is an essential component of the Arma-Chek R covering system. All joints shall always be both adhered with ArmaFlex adhesive and finished with Arma-Chek R Mastic to ensure fully-effective securement and a final seal against water and water-vapour ingress.

Arma-Chek R Mastic shall be used only for surface contact temperatures of -50°C to $+120^{\circ}\text{C}$ (-58°F to 248°F).

Important Note: It is essential to use ArmaFlex Cleaner to remove the Arma-Chek R release-agent coating and any adhesive residue from the Arma-Chek R surface before applying Arma-Chek Mastic.



Do not use alternative cleaners since they may cause a weakening of the mastic bond.

Allow 4 hours adhesive curing time before using ArmaFlex cleaner close to adhered joints.

Be sure to wait at least 10 minutes before applying Arma-Chek Mastic after cleaning with Arma-Chek Cleaner.

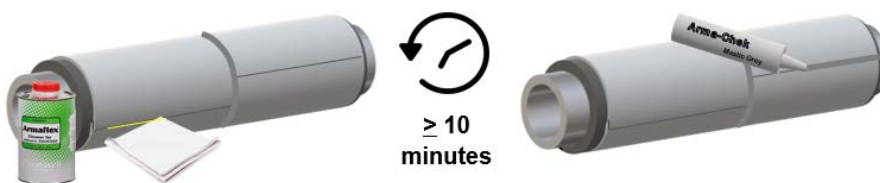

1 litre (1 US quart) of ArmaFlex Cleaner is sufficient to clean the joints present on 50 m^2 (538 ft^2) of installed Arma-Chek R.

The mastic temperature shall not be allowed to drop below 5°C (42°F) until fully cured. If conditions cannot be maintained, contact Armacell Energy for advice.

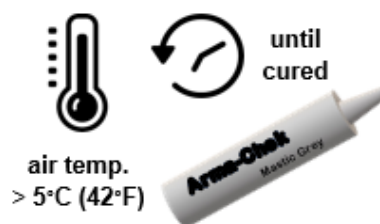

Arma-Chek Mastic sealant cures at a rate of 8 hours per 1 mm (0.04 in.) thickness of mastic at 20°C (68°F) and 50% relative humidity. For a 3 mm (0.12 in.) thick bead this would take 24 hours.

High temperatures and high humidity will increase the curing rate (shorten cure time), but low temperatures and low humidity environments will increase the curing rate of Arma-Chek Mastic. For 3 mm (0.12 in.) thick bead with low humidity, low temperature (e.g. +5°C (41°F) and 50% relative humidity) the curing time would increase to approximately 5 days.

ArmaFlex Cleaner shall not be used to clean the surface of Arma-Chek Mastic before or after curing.

Do not clean finished applications until mastic is completely cured. Use water and a general cleaning agent and wait a minimum of 72 hours after application in high-temperature/high-humidity conditions, or 7-9 days in low-temperature/low-humidity conditions.



Do not use solvent cleaner to clean Arma-Chek Mastic

Arma-Chek Mastic

APPLICATION OF MASTIC BEADS

Arma-Chek R Mastic is an essential component of the Arma-Chek R Beads of Arma-Chek Mastic sealant shall be applied a minimum of 10 mm (0.4 in.) wide and 3 mm (0.12 in.) thick. The centre line of the mastic bead shall be a minimum of 3 mm (0.12 in.) from either side of the overlap edge. The surface onto which the bead is applied shall be dry and clean.

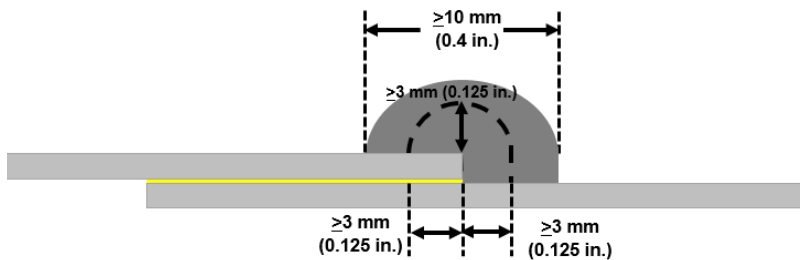

Arma-Chek Mastic bead position

The position of the bead is important for system integrity: use of masking tape or marked lines can assist in ensuring that the bead is applied centrally on the joint.

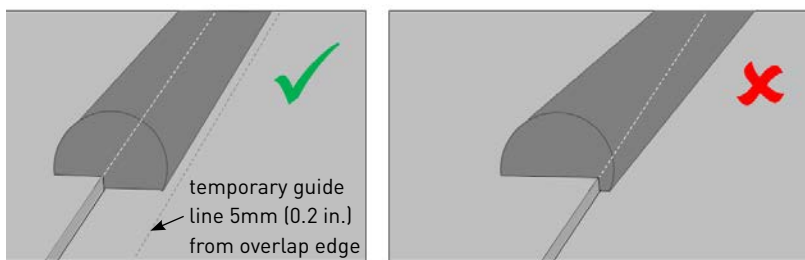

1 cartridge (290 ml (9.8 US fl. oz.)) of Arma-Chek Mastic sealant will form a bead to seal approx. 10 meters (33 ft.) of Arma-Chek R joints, provided there is no waste. (Subject to approval by Energy Technical / Application team). The bead of mastic shall be a minimum of 10 mm (0.4 in.) wide and 3 mm (0.12 in.) thick.



1 cartridge (290ml (9.8 US fl.oz.))
Arma-Chek M sealant = 10 linear metres (33 ft.)

Arma-Chek Mastic

CONTINUATION/TERMINATION OF MASTIC BEADS

Beads of Arma-Chek Mastic sealant should be applied as a single continuous length. Where this is not possible, the applicator shall terminate the bead down to the surface of the Arma-Chek R, taking care not to thin the bead. Before continuing application, the applicator shall press the cartridge tip into the end of the previously applied bead and continue to apply mastic and continue to apply the bead as before.

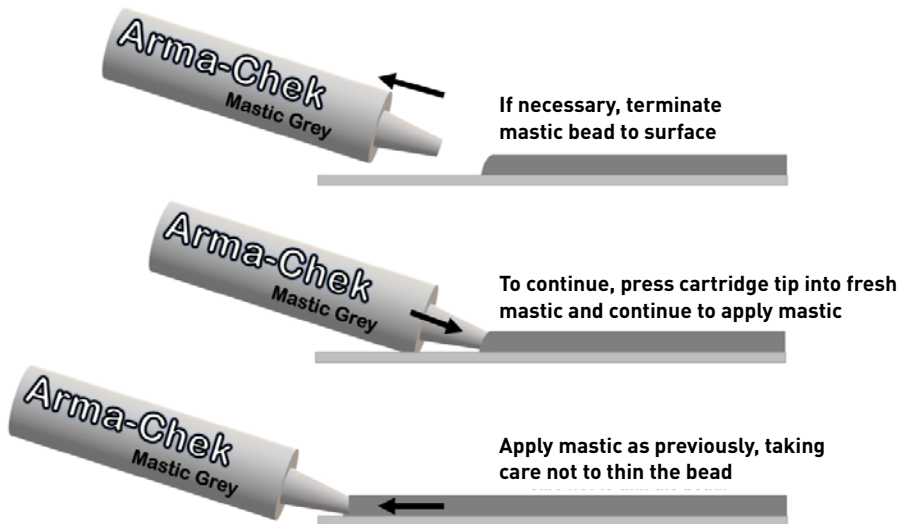

The same technique of pressing the nozzle into the previously applied bead shall be used when ending a circumferential bead.

Intersections with uncured mastic beads shall be dealt with in a similar way, by starting and terminating the bead by pressing the nozzle into the previously applied bead.

If the intersection is with a cured mastic bead then the crossing bead may be applied over the existing bead.

There shall be no gaps or discontinuities between intersecting mastic beads or between the mastic and Arma-Chek R.

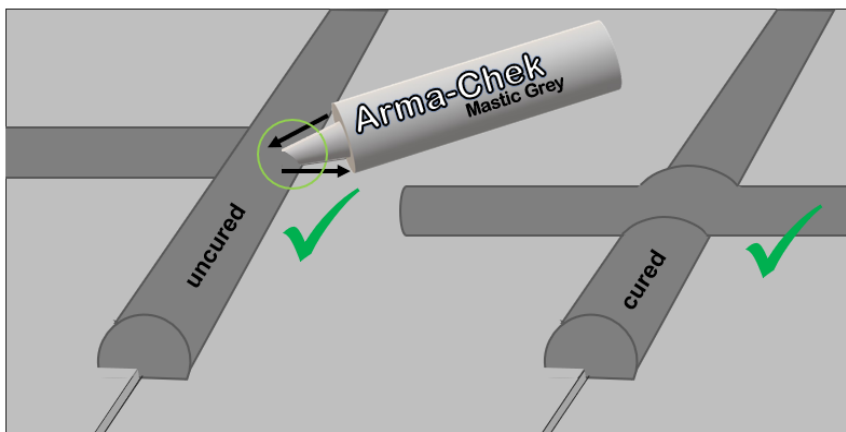

Arma-Chek Mastic

FINISHING OF MASTIC BEADS

Beads of Arma-Chek Mastic sealant shall be finished to a smooth, even finish, using a mastic tool or a finger.

The finish of the Arma-Chek Mastic sealant can be enhanced by 'masking off', 5 mm either side of the seams and joints, prior to the application of the Arma-Chek Mastic sealant. Remove the 'masking' tape while the Arma-Chek Mastic sealant is in its wet state.

When smoothing the sealant, do not reduce the bead size below a minimum of 10 mm (0.4 in.) wide and 3 mm (0.12 in.) thick and, avoid thinning the edge of the mastic bead excessively.

Water (if desired it may contain a few drops of detergent per 100 ml (0.3 fl. oz.) of water) is helpful during the application and smoothing of the mastic bead. Do not use excessive amounts of detergent as this can present a risk to the integrity of the mastic.

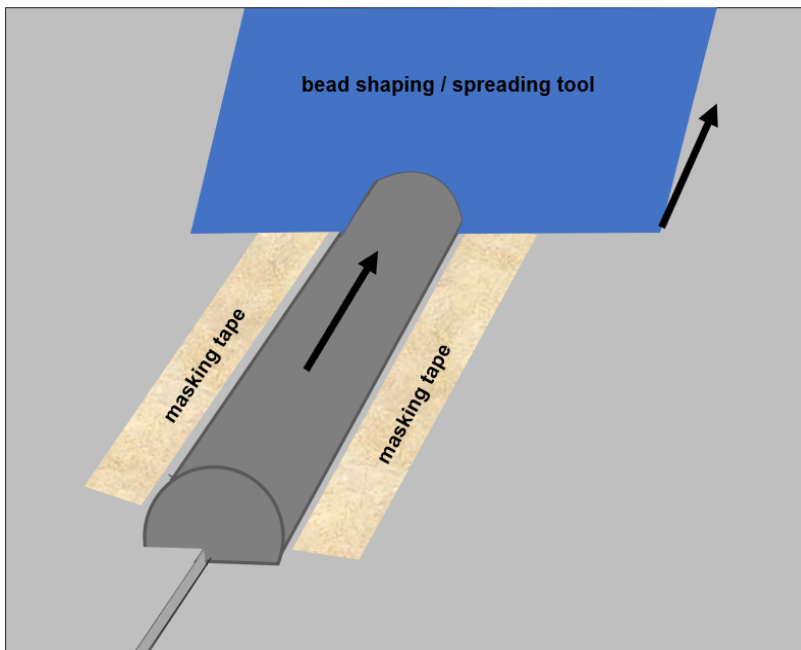

Standard Application Method, Arma-Chek R

Wait between 3 & 24 hours depending on the method of adhesive fixing from application of ArmaFlex or ArmaSound layers before applying Arma-Chek R. For applications that have just overlap fixing, 3 hours wait time is required. For partial and all over adhesive fixing, 6 and 24 hours wait time is required, respectively.



<p>Horizontal Piping, $\varnothing < 20$ in. NB.</p> <ul style="list-style-type: none"> - Seams/joints, adhered & overlapped by: <ul style="list-style-type: none"> - 50mm (2 in.) for piping $\varnothing \leq 5$ in. NB - 75mm (3 in.) for piping $6 \leq \varnothing \leq 8$ in. NB - 100mm (4 in.) for piping $9 \leq \varnothing \leq 16$ in. NB - 125mm (5 in.) for piping $18 \leq \varnothing \leq 20$ in. NB - All seams/joints to be over sealed with ArmaFlex Mastic 	
<p>Horizontal Piping, $\varnothing > 22 - 72$ in. NB 1/3 bottom surface area adhesive coverage.</p> <p>Horizontal piping above 72" NB & Vertical Piping, all \varnothing, Horizontal/Vertical Vessels/Equipment</p> <ul style="list-style-type: none"> - All-over adhesive covering - Seams/joints, adhered & overlapped by minimum 50mm (2 in.) - All seams/joints to be over sealed with ArmaFlex Mastic 	

\varnothing represents the nominal diameter of uninsulated pipework

Terminations

PIPE/VESSEL SURFACE TEMPERATURES BETWEEN -50°C (-58°F) AND 100°C (212°F)

Where the Arma-Chek R terminates at valves, flanges, etc, it must be sealed with an end cap. For pipe/vessel temperatures between -50°C (-58°F) and 100°C (212°F) an Arma-Chek R end cap may be used. For pipe/vessel temperatures below -50°C (-58°F) or above 125°C (257°F), use rigid materials such as metal jacketing instead of Arma-Chek R

Cut an end cap disc of Arma-Chek R to fit closely to the pipe and over the insulation. Cut 25-50mm (1-2 in.) flaps to fold over the insulation to create an overlap.

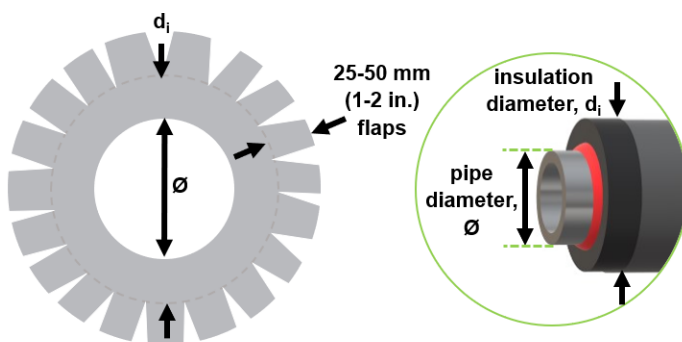

Cut Arma-Chek R end cap disc.



Glue the end cap over the insulation termination using ArmaFlex Adhesive.

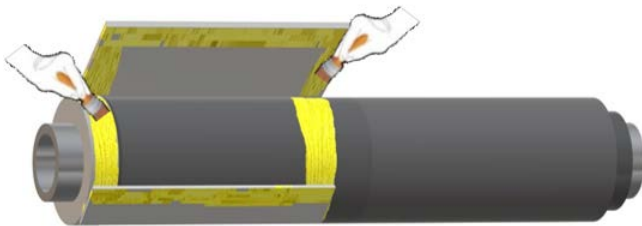

Apply next section of Arma-Chek R, gluing into place with ArmaFlex adhesive and overlapping the end cap.

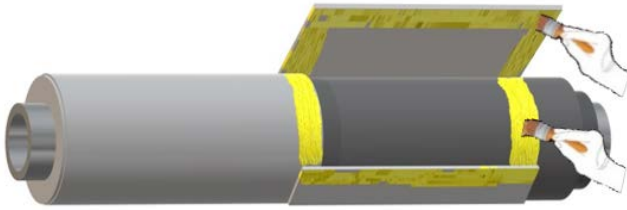

Apply subsequent section of Arma-Chek R, gluing into place with ArmaFlex adhesive and overlapping the previous piece.

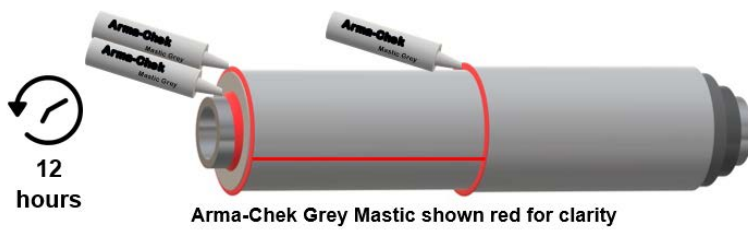

After 12 hours apply Arma-Chek Mastic to all joints/seams.

The bead of ArmaFlex Mastic between the pipe and the Arma-Chek R shall be a minimum of 10 mm x 10 mm (0.4 x 0.4 in.). The temperature limits for Arma-Chek Mastic shall be respected.

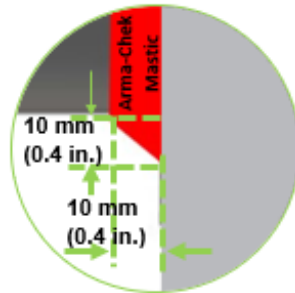

Terminations

PIPE/VESSEL SURFACE TEMPERATURES ABOVE 100°C (212°F)

When pipe surface temperatures exceed 100°C (212°F) use a rigid temperature-resistant end cap, eg stainless steel. A metal end cap shall have no direct contact with the pipe surface.

This shall be insulated from the pipe with a strip of ArmaGel HT insulation or ceramic fibre bandage (or other suitable heat resistant insulation layer) which shall first be applied to the surface of the pipe.

For operating temperatures up to +125°C (257°F) a ceramic fibre bandage shall be minimum of 3 mm thick (or use a standard 5mm thick strip of ArmaGel HT). For higher temperatures the thickness of ArmaGel HT strip or ceramic fibre bandage shall be increased to ensure that the contact temperature between the Arma-Chek R covering and the steel end cap remains less than +100°C (212°F).

The interface between the end cap and the Arma-Chek R shall be layered to shed water as shown in the two configurations drawn. The end cap may also be formed as a cone to shed water.

Arma-Chek Mastic or high-temperature silicone shall be used to create a water seal between the end cap and the pipe.

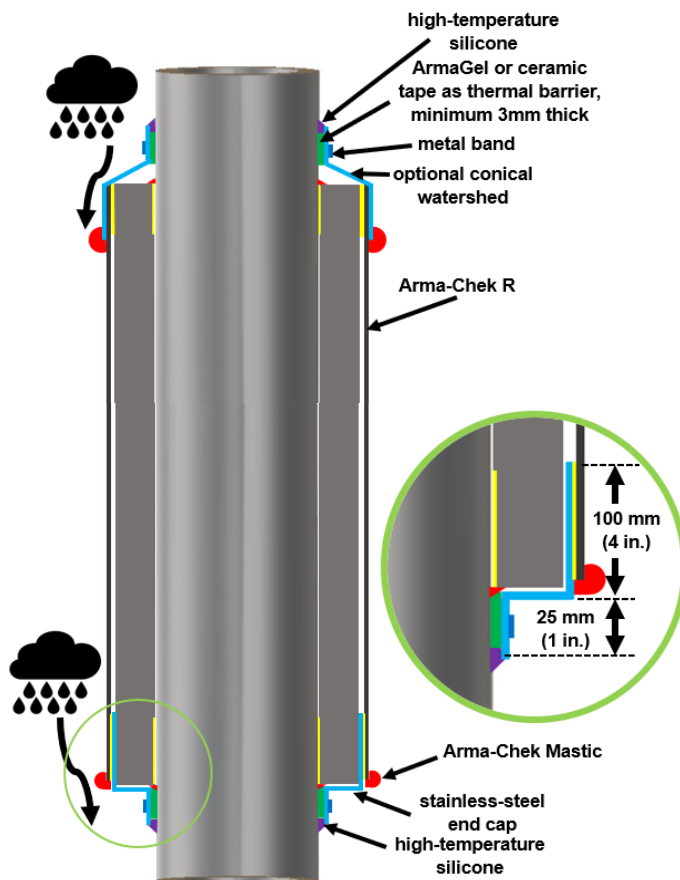

High-temperature end caps.

Valve / Flange Boxes & Terminations

Valve/flange boxes may be constructed from ArmaFlex insulation and covered with Arma-Chek R. Alternatively metal boxes may be used and lined with ArmaFlex or other insulation material, depending on the pipe temperature.

In any case care should be taken that the temperature inside the box will not cause the temperature limits of Arma-Chek R and any mastic sealant to be exceeded.

Where metal end caps are used inside boxes, they shall terminate on the outside of the Arma-Chek R.

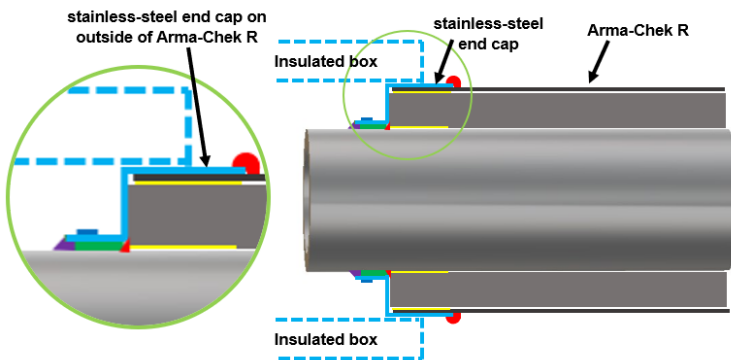

Penetrations

Use Arma-Chek Mastic sealant to seal Arma-Chek R around pipe penetrations, steelwork, hangers, trace heating cable, and all other areas that require sealing against water or water-vapour ingress. An extension may be required to penetration insulation to reduce heat transfer.



Seal penetrations with Arma-Chek Mastic (shown red for clarity)

Pipe Supports / Cradles

Cut Arma-Chek R to fit cradle base. Feather the edges by minimum 10mm (0.4 in.) to create overlap.

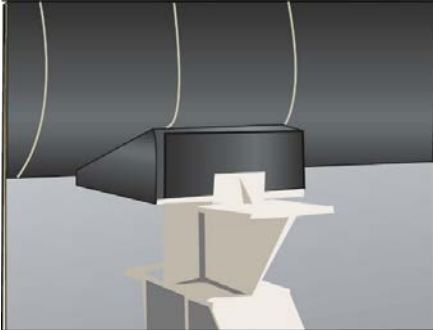

Adhere around cradle upstand base.

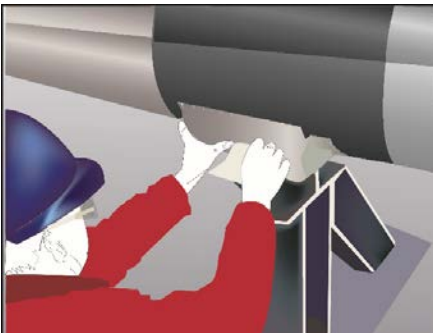

Ensure that a close fit is achieved.

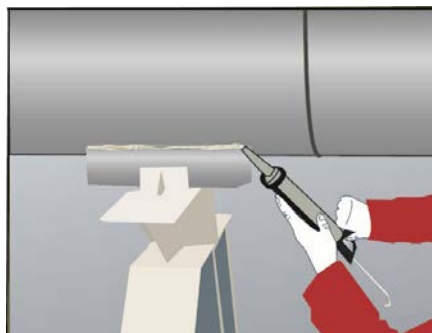

Apply Arma-Chek R around pipe/cradle and seal with Arma-Chek R.

Fabrication of Fittings

Sequence of installation of Arma-Chek R pieces shall be such that the latest piece is installed overlapping and higher than the previous piece.

Fabrication of common fittings from Arma-Chek R is detailed below.

Fabrication Example: Elbow

SEGMENTED BEND

A segmented bend/long radius elbow can be manufactured using 3 measurements:

- 1) Elbow centre radius, R , the distance from the centre of the pipe to the weld
- 2) Circumference around outside of insulation, C_i measured by wrapping a strip of Arma-Chek R around the insulated surface
- 3) Insulation outside diameter, d_i measured on the outside of the insulated surface, including 2x Arma-Chek R thickness.

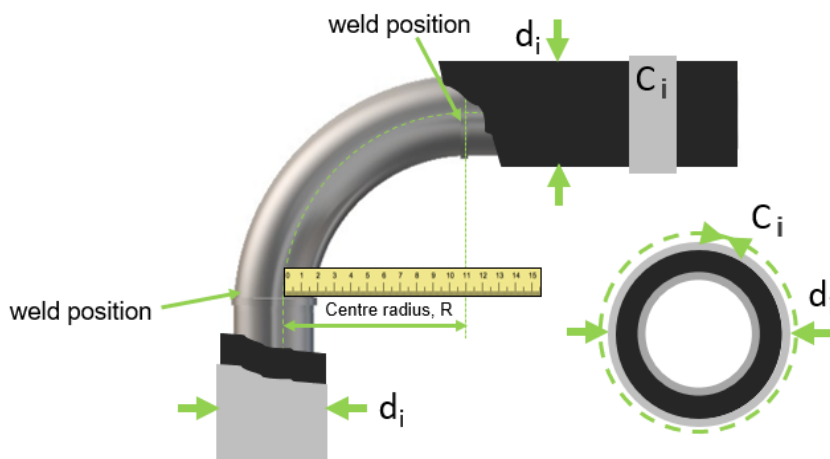

Consult table below to determine quantity of segments. In addition to the segments, 1 starter and 1 finisher piece are required.

pipe size NB (in.)	pipe OD (mm)	centre radius (mm)	quantity (#) of segments	L1 (mm) = 100(#+1)
0.5	21.3	38	mitre	
0.75	26.7	28.5	mitre	
1	33.4	38	mitre	
1.25	42.2	47.5	mitre	
1.5	48.3	57	mitre	
2	60.3	76	3	400
2.5	73	95	3	400
3	88.9	114	3	400
3.5	101.6	133	3	400
4	114.3	152	4	500
5	141.3	190	4	500
6	168.3	229	4	500
8	219.1	305	5	600
10	273.1	381	7	800
12	323.9	457	7	800
14	355.6	533	9	1000
16	406.4	610	9	1000
18	457	686	11	1200
20	508	762	11	1200
22	558.8	838.2	11	1200
24	610	914	13	1400
26	660.4	990.6	13	1400
28	711.2	1066.8	13	1400
30	762	1143	13	1400
32	812.8	1219.2	13	1400
34	863.6	1295.4	15	1600
36	914	1372	15	1600
38	965.2	1447.8	15	1600
40	1016	1524	15	1600
42	1066.8	1600.2	15	1600
44	1117.6	1676.4	17	1800
46	1168.4	1752.6	17	1800
48	1219.2	1828.8	17	1800
50	1270	1905	19	2000
52	1320.8	1981.2	19	2000
54	1371.6	2057.4	19	2000
56	1422.4	2133.6	21	2200
58	1473.2	2209.8	21	2200
60	1524	2286	21	2200
62	1574.8	2362.2	21	2200
64	1625.6	2438.4	23	2400
66	1676.4	2514.6	23	2400
68	1727.2	2590.8	23	2400
70	1778	2667	23	2400
72	1828.8	2743.2	23	2400

If required, increase quantity of segments for greater insulation thicknesses.

Make a Template

$L_1 = (1 + N \text{ segments}) \times 100\text{mm (4in.)}$



Draw two horizontal lines, 10mm apart, and two vertical, lines distance L1 apart. Find dimension L1 from the segment table

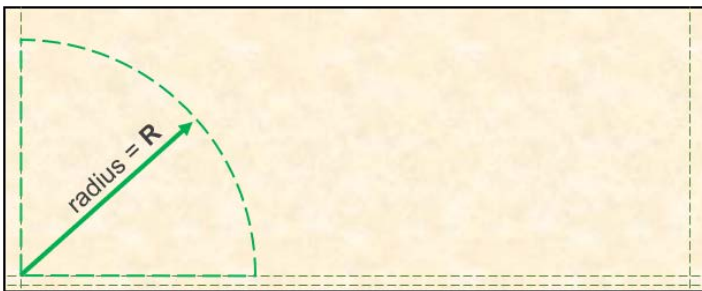

Draw an arc of radius = **R** from the intersection of the left-hand vertical line and upper horizontal line

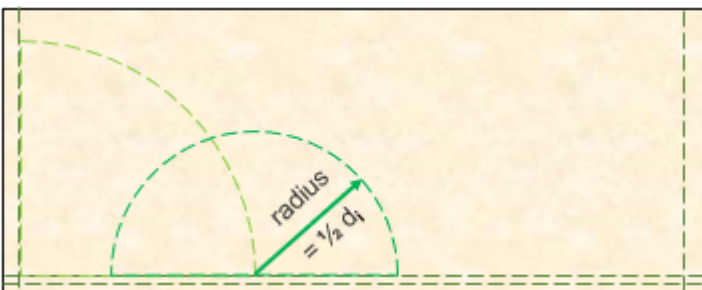

Draw a second arc of radius = $\frac{1}{2} d_i$ from the intersection of the first curve and the upper horizontal line

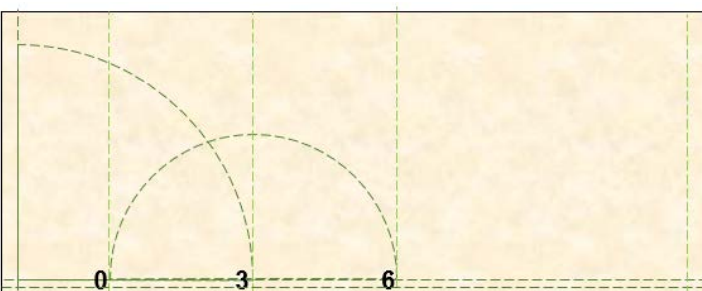

Draw 3 vertical lines from the intersections of the curves with the base line. Label the lines 0, 3, 6

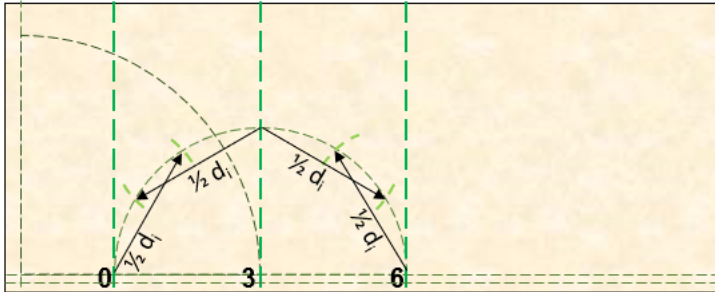

Draw 4 arcs of radius = $\frac{1}{2} d_i$ from the intersections of the vertical lines with the second curve, to intersect the second curve

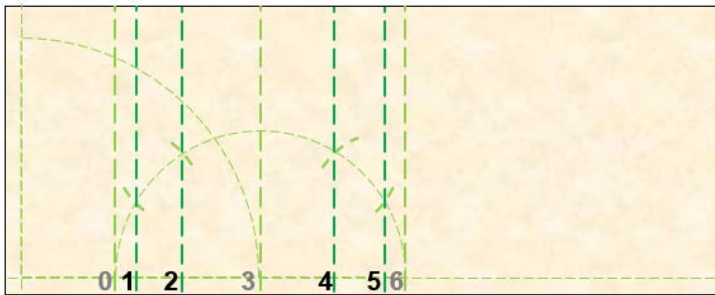

Draw 4 more vertical lines through the intersections of the arcs with the second curve. Label these vertical lines 1, 2, 4, 5.

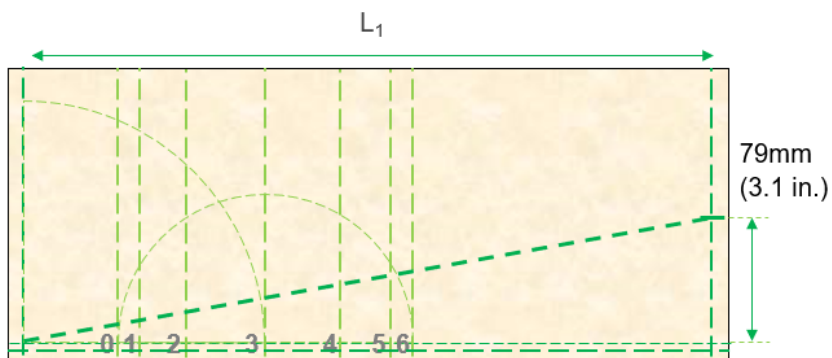

Mark 79mm (3.1 in.) up on the right-hand vertical line from the upper horizontal line and then join the mark to the intersection of the upper horizontal line and left-hand vertical line.

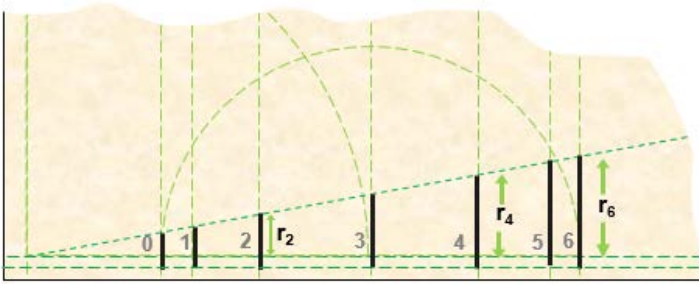

Mark the length, r_1 to r_6 of the vertical lines between the diagonal line and the bottom horizontal line. These lengths r_0 to r_6 will need to be transferred to a new template.

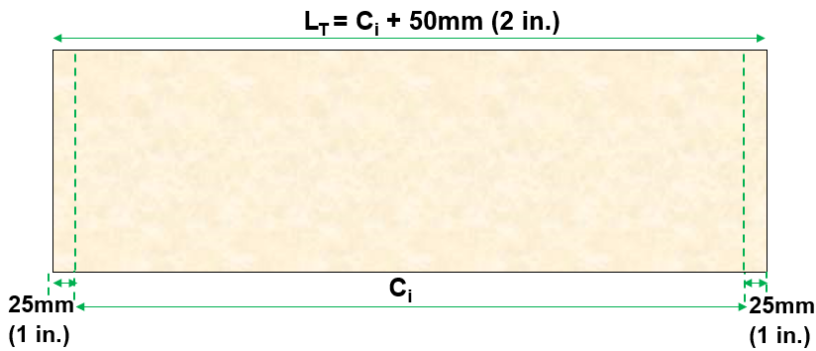

Use a new template and mark out the length L_T to equal the circumference $C_i + 50\text{mm}$ (2 in.). Mark a vertical line 25mm (1 in.) in from each side

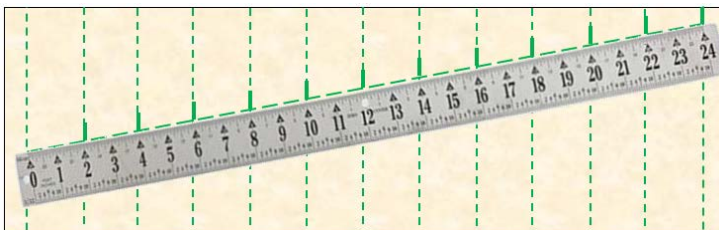

Draw a diagonal line of any length divisible by 12 and mark the line into 12 parts. Larger elbows (e.g. > 558 mm (22 in.) insulated diameter.) may require division into 24 parts. Use these marks to draw vertical lines. This is a simple technique which makes dividing the template into equal parts much easier.

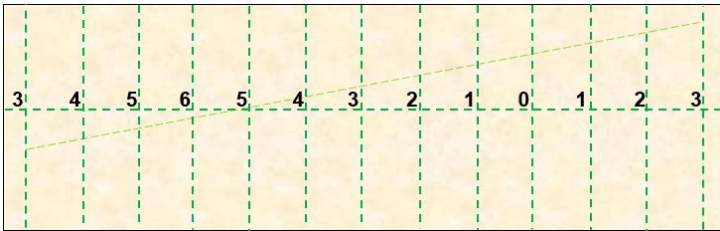

Draw a horizontal line in the centre and number the intersections as shown

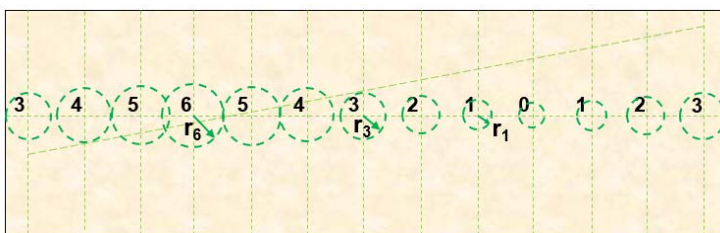

Draw circles using the lengths r_0 to r_6 from the previous template as the radii of circles. Centre the circles on the intersections of the horizontal line with the numbered vertical lines

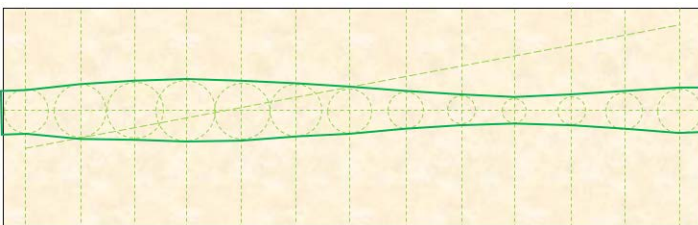

Draw smooth lines to join the circles.



Cut out the segment template

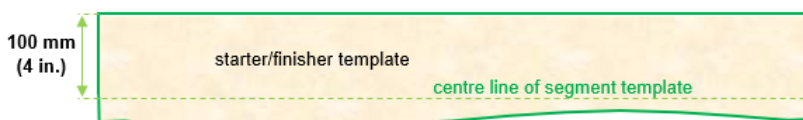

Create starter/finisher template by adding 100mm (4 in.) to half of a segment piece

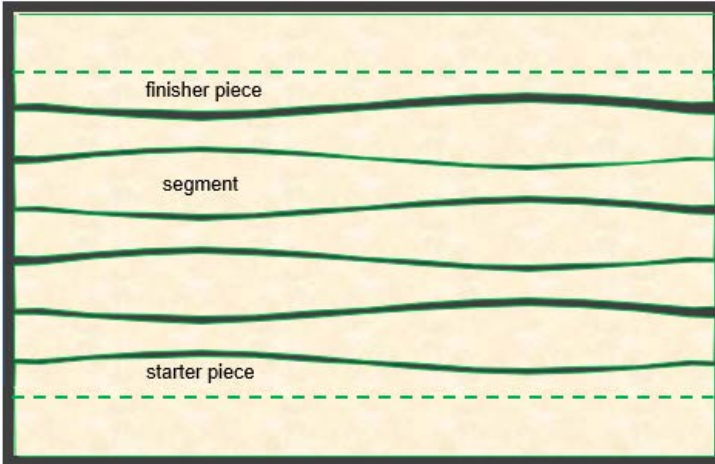

Use the template to mark out the Arma-Chek R with a starter piece, appropriate quantity of segments and a finisher piece.

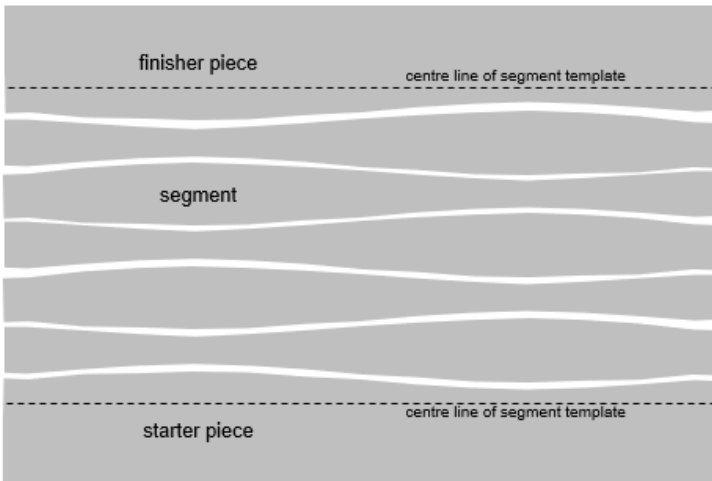

Cut out the pieces of Arma-Chek R

When applying Arma-Chek R always ensure that the overlaps are positioned to shed water (roof tile effect) so that an upper piece always overlaps/fits over a lower piece. Each piece shall overlap the previous piece by > 10 mm (0.4 in.)

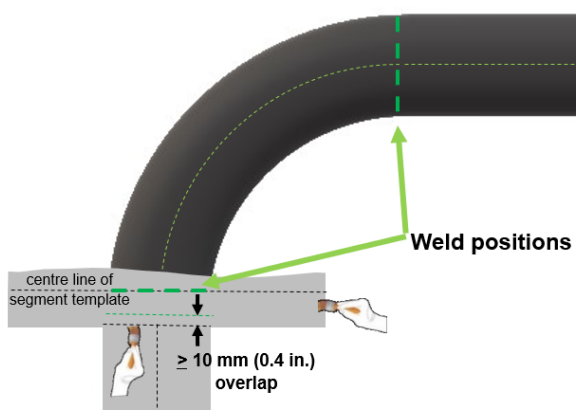
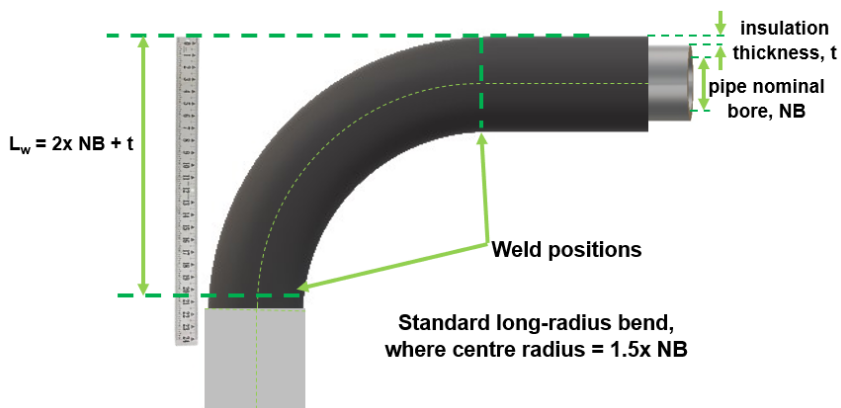
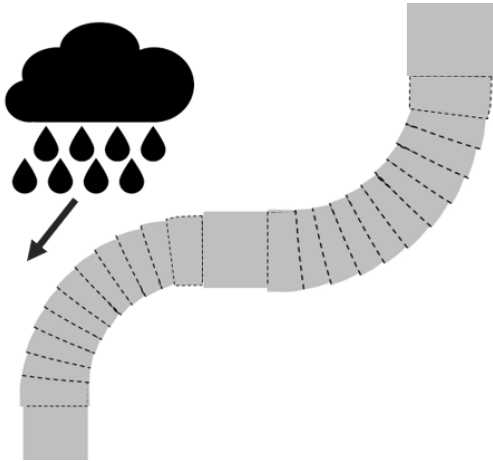

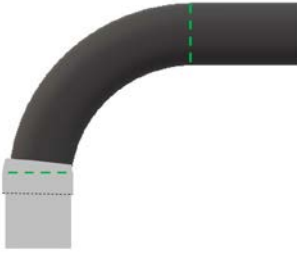

Complete starter piece

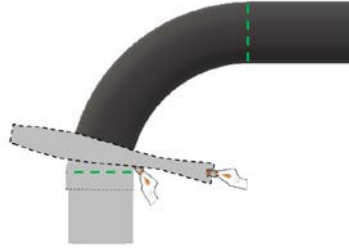

Apply next segment

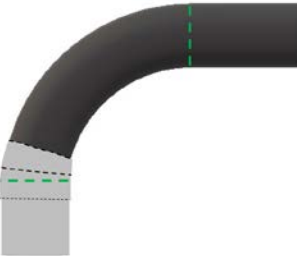

Adhere segment

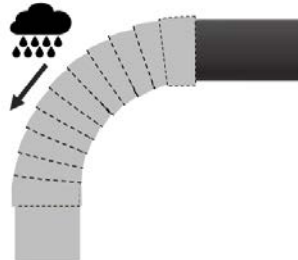

Continue to apply remaining pieces, and apply/adhere finisher piece

Fabrication Example: Elbow

MITRED ELBOW

A mitred elbow can be manufactured using 3 measurements:

- 1) Circumference around outside of insulation, **C_i** measured by wrapping a strip of Arma-Chek R around the insulated surface
- 2) Insulation outside diameter, **d_i** measured on the outside of the finished insulation surface, additionally including 2 x Arma-Chek R thickness.
- 3) Leg length, **L**

Create a template:

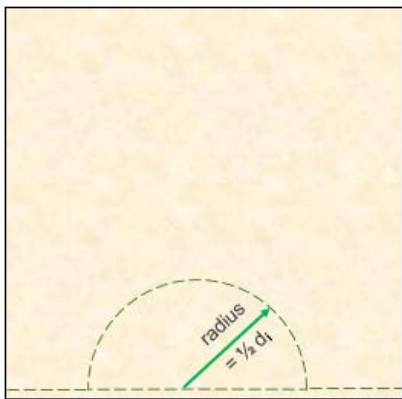
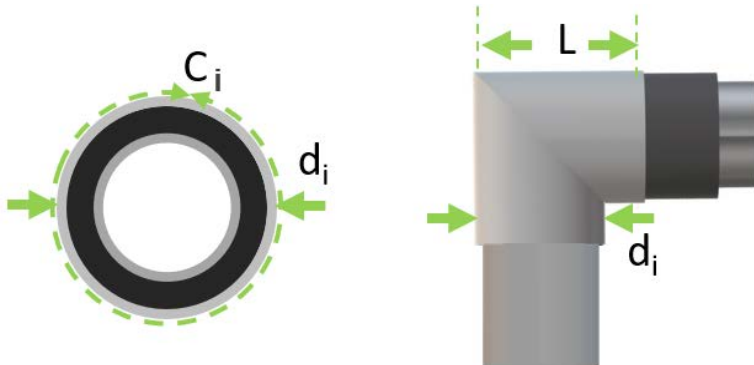

Draw a horizontal line and a semi-circular arc of radius = $\frac{1}{2} d_i$

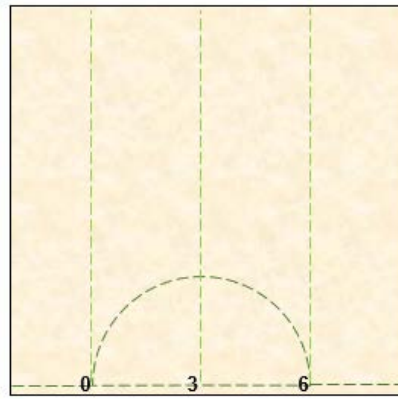

Draw 3 vertical lines from the intersections of the curves with the base line.
Label the lines 0, 3, 6

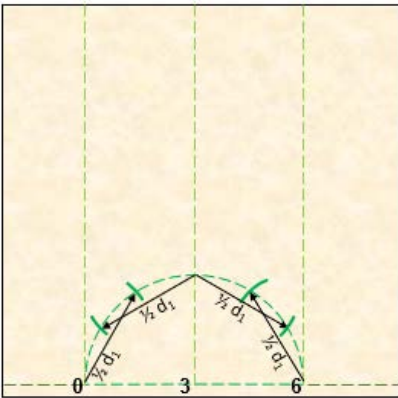

Draw 4 arcs of radius = $\frac{1}{2} d_i$ from the intersections of the vertical lines with the second curve, to intersect the second curve

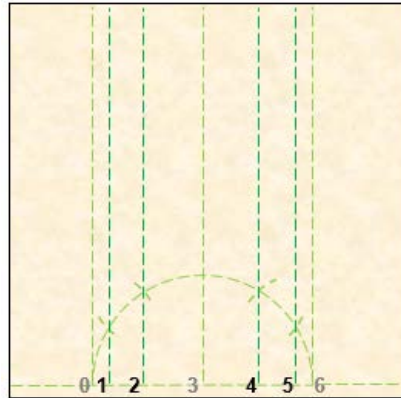

Draw 4 more vertical lines through the intersections of the arcs with the second curve. Label these vertical lines 1, 2, 4, 5

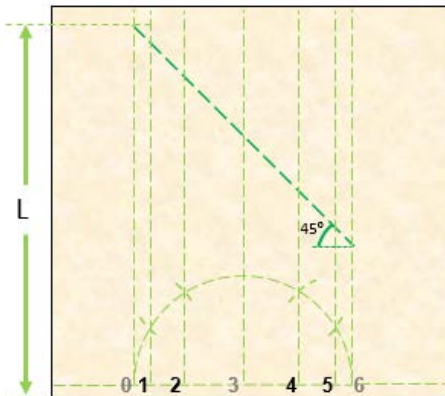

Draw a line at 45° from the horizontal for a 90° degree elbow (or 22.5° from the horizontal for a 45° elbow). The height of the diagonal above the base determines the elbow length, L

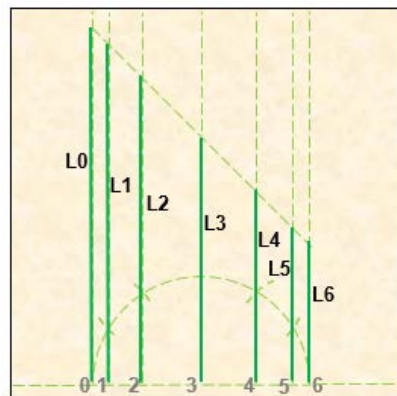

Mark and measure the length of vertical lines between the diagonal line and the horizontal base line. Label these vertical lines L0, L1, L2, L3, L4, L5, L6

Create a new template:

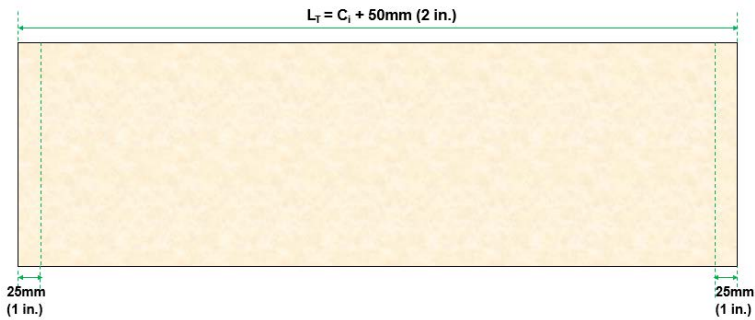

Use a new template of length L_T to equal the circumference $C_i + 50\text{mm (2 in.)}$. Mark a vertical line 25mm (1 in.) in from each side.

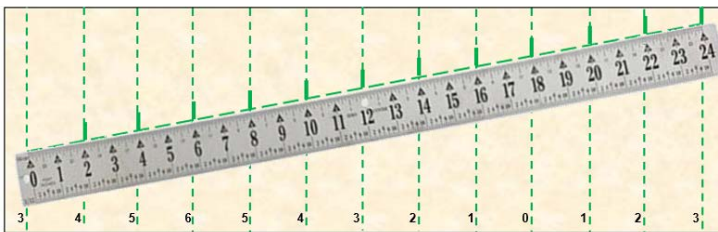

Draw a diagonal line of any length divisible by 12 and mark the line into 12 parts. Larger elbows (e.g. > 558 mm (22 in.) insulated diameter.) may require division into 24 parts. Use these marks to draw vertical lines and label with numbers as shown.

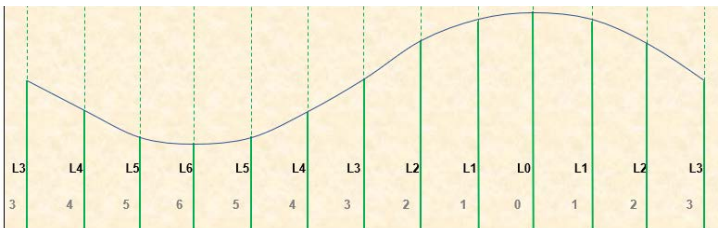

Mark the lengths L_0 to L_6 as previously measured, with L_0 at position 0, L_1 at position 1, etc. Join the tops of the lines with a smooth curve.

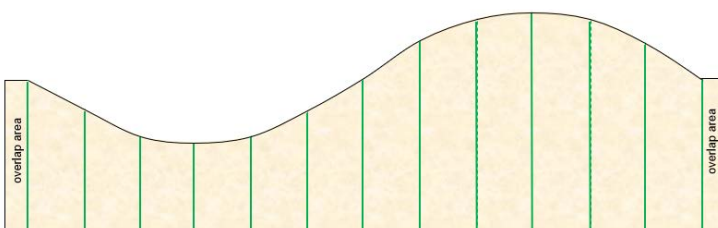

Cut along the curve and extend horizontal cuts into the overlap areas.

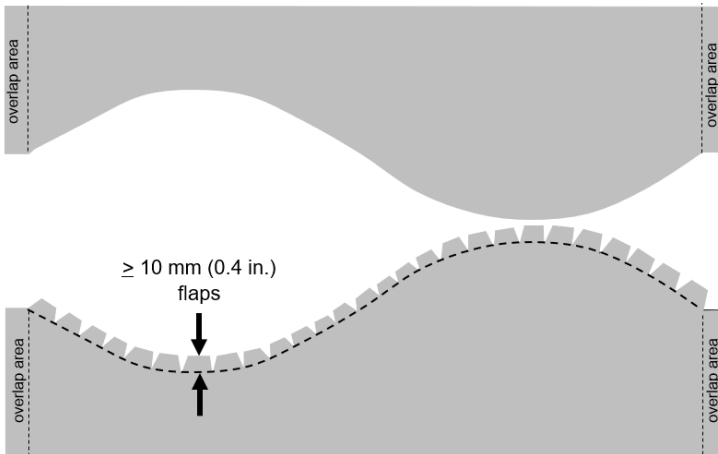

Use template to cut out two pieces, ensuring that minimum 10mm (0.4 in.) feathered overlaps are added to one edge.

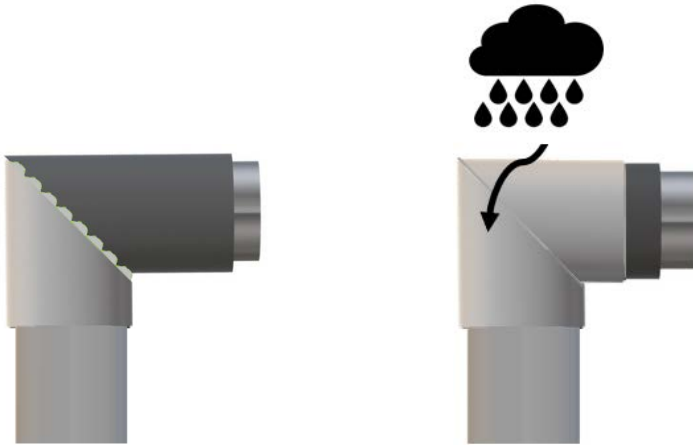

Apply the first, lower, piece with flaps positioned to be under second piece

Ensure that second piece will be overlapping the flaps of the first so that it will shed water

Fabrication Example: T Piece

EQUAL T PIECE

Measure the external circumference, C , and diameter, d , over the Arma-Chek R.
Use these measurements to create a template for marking out how to cut the Arma-Chek R.

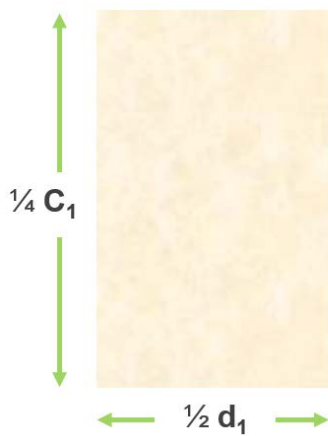
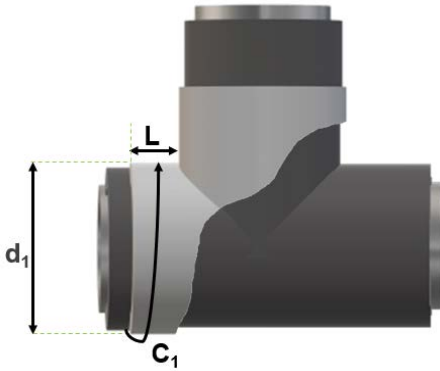

Cut a rectangular template,
length = $\frac{1}{4} c$, height = $\frac{1}{2} d_1$

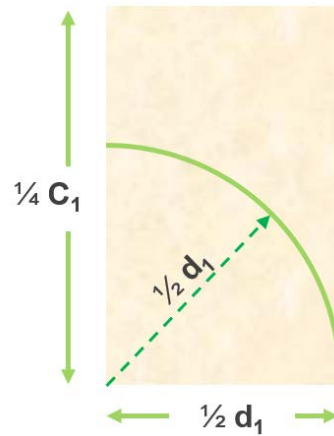

Draw an arc,
radius = $\frac{1}{2} d_1$

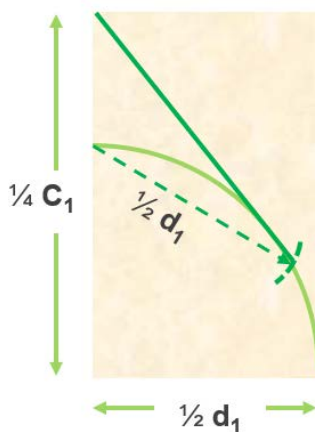

Use template to mark out two sheets of Arma-Chek R as shown below, marking 2 lines 25mm from each end.

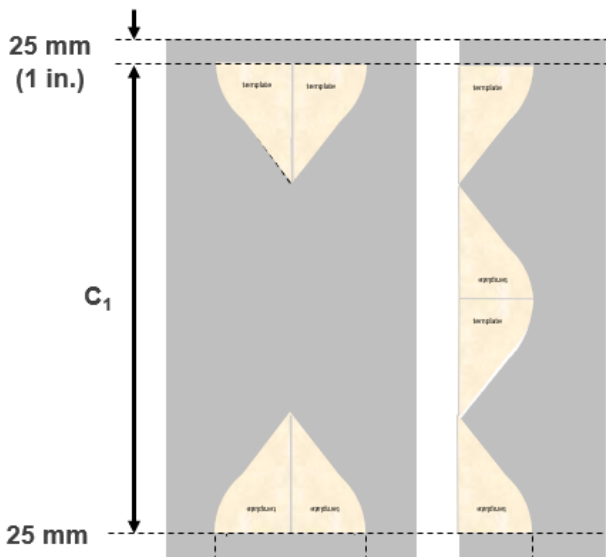

L = desired leg lengths of T piece (typically > 50mm (2 in.)).

The Arma-Chek R overlaps must be positioned to shed water. In the example shown the vertical branch must fit over the horizontal branch to shed water, so 10mm flaps must be added to the markout for the horizontal piece so that when cut out it will look as shown:

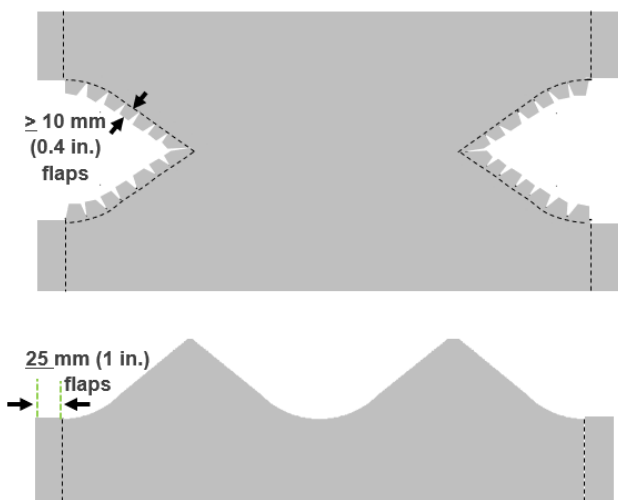

Cut out Arma-Chek R pieces and wrap around T piece, applying adhesive to secure joints, and 50 mm (2 in.) strips of adhesive between underlying insulation and ArmaSound Barrier to seal.

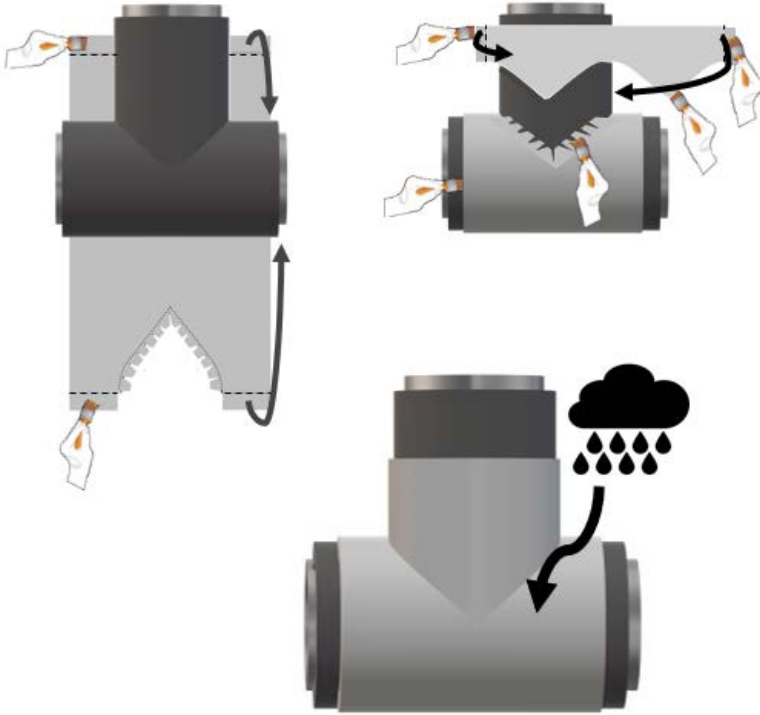

Ensure that flaps will be positioned under a higher overlap so that they will shed water.

Fabrication Example: T Piece

UNEQUAL T PIECE

Measure the external circumferences, **C1** and **C2**, and diameters **d1** and **d2**, over the ArmaFlex insulation.

Use these measurements to create a template for marking out how to cut the ArmaSound Barrier.

Leg length $L = 50\text{mm}$ (2 in.) or longer.

Start by preparing a piece of Arma-Chek R to wrap around the smaller branch.

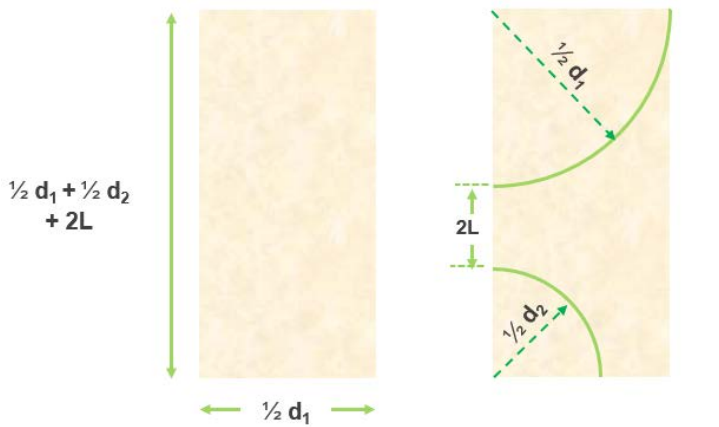
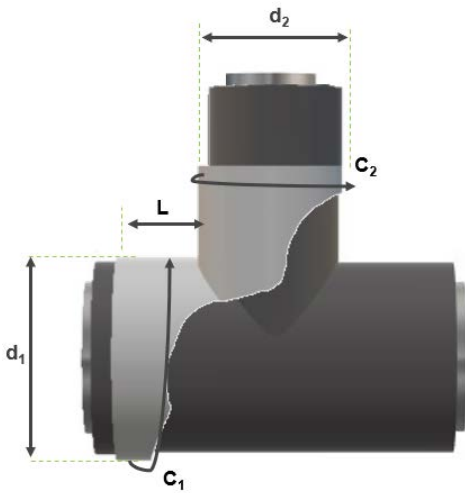

Use a rectangular template,
height = $(\frac{1}{2} d_1 + \frac{1}{2} d_2 + 2L)$,
width = $\frac{1}{2} d_1$

Draw two arcs from
the corners,
radius = $\frac{1}{2} d_1$ and $\frac{1}{2} d_2$

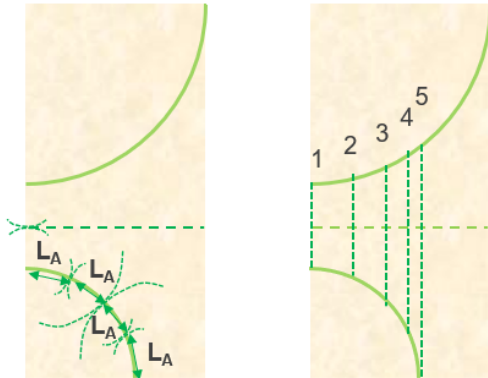

Divide the gap between the arcs into 2 equal parts, length = $\frac{1}{2} L$ and draw a horizontal line. Divide the smaller arc into 4 parts of equal arc length, L_A

Starting from the divisions and ends of the smaller arc, draw horizontal lines to join the larger and smaller arcs. Label 1 to 5

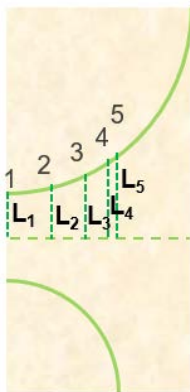

Measure the distances between the larger arc and the horizontal dividing line and label L_1 to L_5

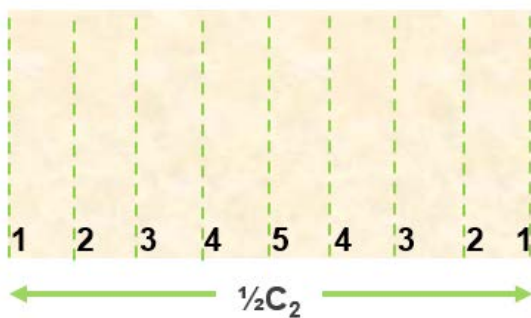

Cut a new template, length = $\frac{1}{2} C_2$ and divide into 8 parts. Label as shown

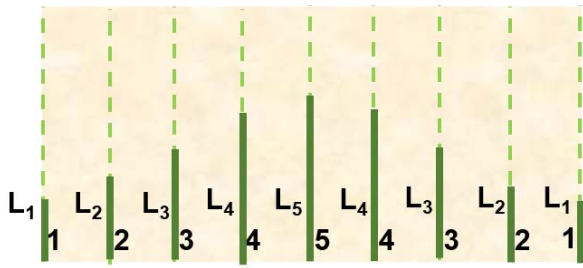

Transfer the measurements L1 to L5 onto the template at the positions 1 to 5

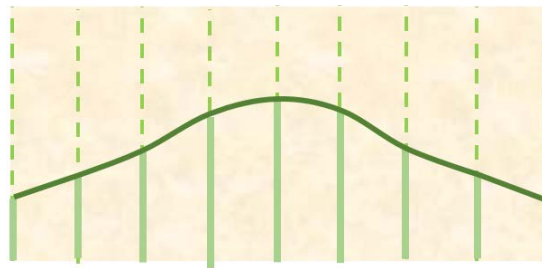

Join the tops of the lines together to form a curve. Cut out bottom part of template.

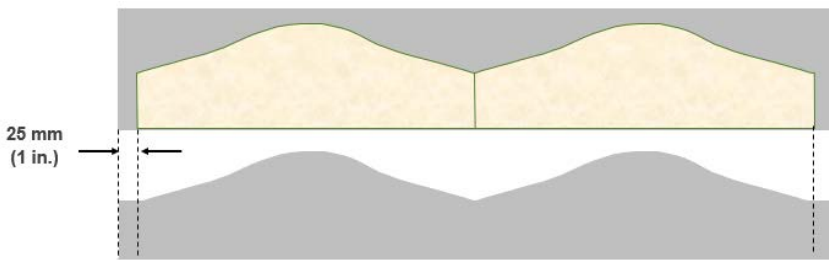

Use template to mark out and cut out the Arma-Chek R for the small branch of the T piece, making sure to add 25mm (1 in.) overlap at either end.

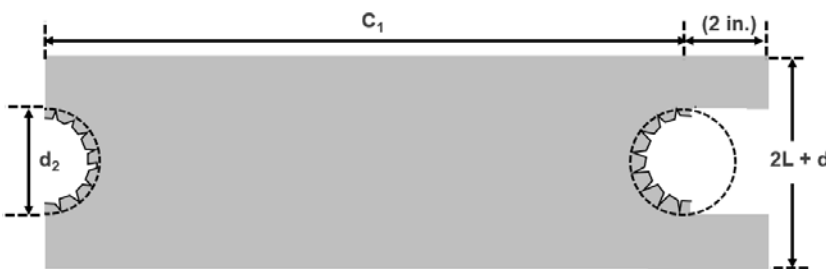

Cut a sheet of Arma-Chek R for the body, length C₁ + 50 mm (2 in.) and width (2L + d₁). Cut out a semi-circular disc of diameter d₂, at one end. Cut out another disc of diameter d₂, at distance of centres C₁ from the first disc but add 10 mm flaps to create an overlap.

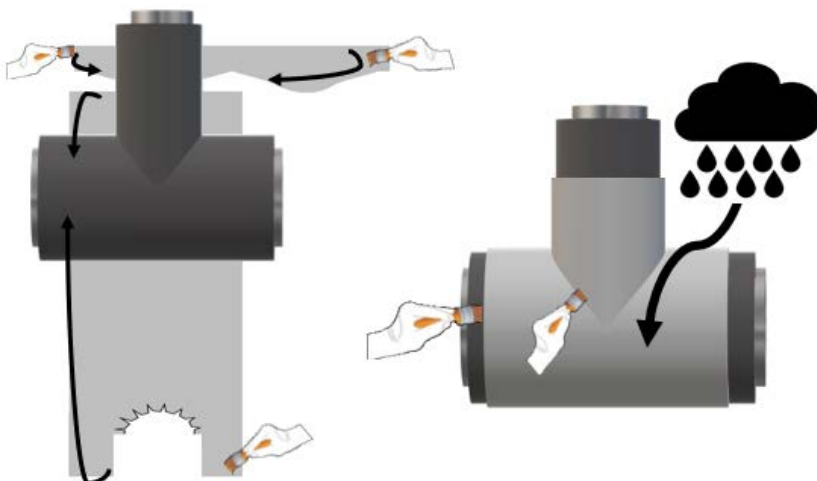

Fabrication Example: Reducer

REDUCTION IN PIPE DIAMETER

Measure the height, **h**, of the reducer.

Wrap Arma-Chek R around the larger pipe and measure the diameter, **d1**.

Wrap Arma-Chek R around the smaller pipe and measure the diameter, **d2**.

Cut a strip of Arma-Chek R which fits around the larger pipe easily. Mark it as **C**.

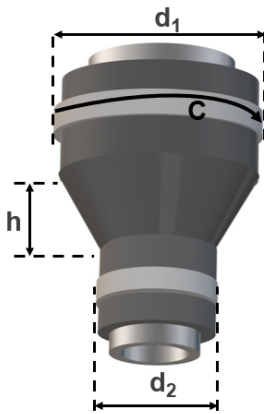

Fix and adhere first (lowest) piece of Arma-Chek R, cutting 10mm flaps for the overlap so that the next layer will shed water.



Create tapered reducer piece from ArmaSound barrier.

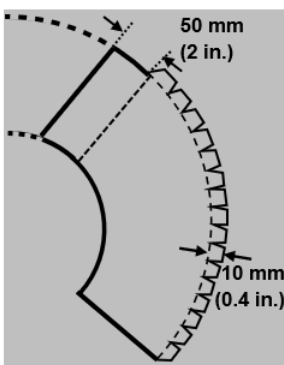
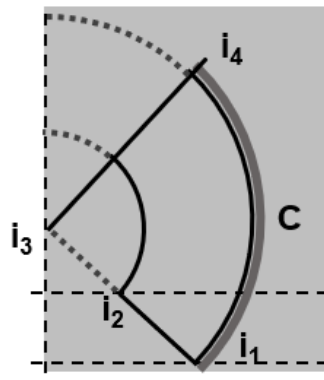
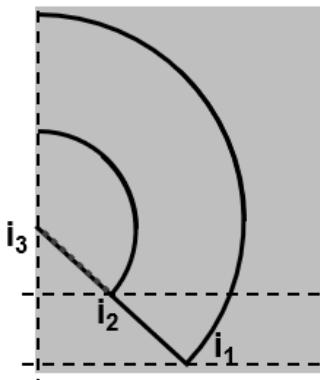
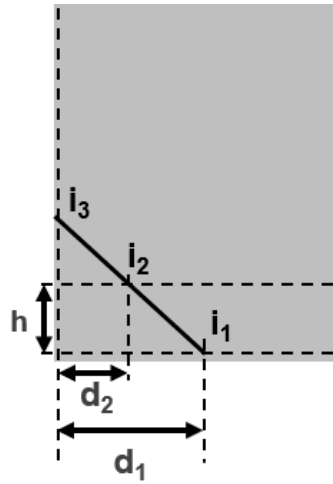
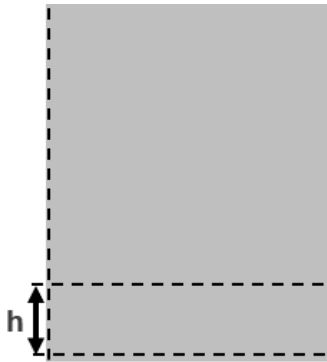

Wrap the Arma-Chek R reducer piece around the reducer, applying adhesive to secure.

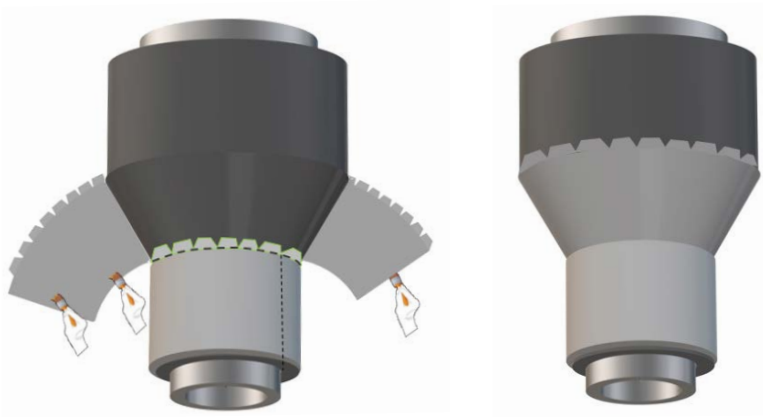

Apply Arma-Chek R above the reducer piece, applying adhesive to secure and ensuring that overlaps are positioned to shed water.



Non-Removable, Non-Metallic Enclosures (Arma-Chek R)

VALVES/FLANGES WITH PIPEWORK OPERATING TEMPERATURES -50°C to $+125^{\circ}\text{C}$ (-58°F to $+257^{\circ}\text{F}$)

Apply Armaflex Industrial, ArmaSound RD240 and ArmaSound Barrier E layers as required by the project specification directly to the body of the valve or flange. The total insulation thickness and build-up of materials shall be the same as for the pipe insulation.

The insulation layering shall follow the contours of the valve/flange and all joints be staggered and adhered with ArmaFlex Adhesive.

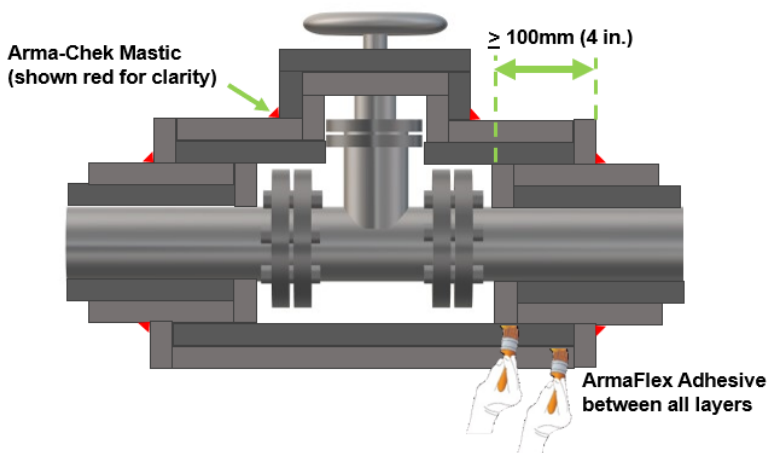

For cold applications the void shall be filled with a loose fill of ArmaFlex or glass wool.

The insulation should extend over the attached insulated piping terminations by a minimum of 100 mm (4 in.) either side of the insulation terminations, and shall be fully fixed with Armaflex Adhesive and sealed with Arma-Chek Mastic. Allowance shall be made for flange bolt removal, if required. The insulation shall be fully covered with Arma-Chek R outer covering.

The construction of valve/flange covers shall follow the general guidance given in the ArmaFlex, ArmaSound and Arma-Chek R Application Guidelines.

If a valve stem penetrates the box, it shall be resealed with Arma-Chek Mastic each time the valve is operated.

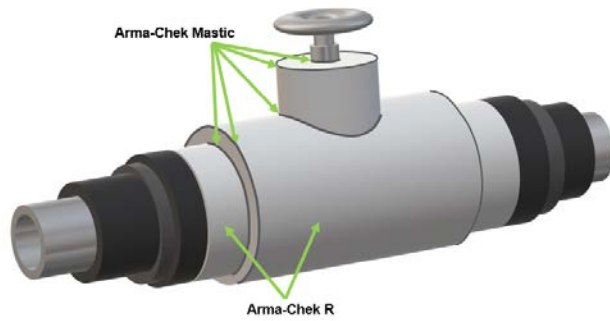

Non-removable, non-metallic enclosure (Arma-Chek R).

Application of Arma-Chek R over other Materials

Arma-Chek R will sometimes be applied over materials other than ArmaFlex or ArmaSound. Compatibility with non-Armacell products shall always be assessed by the project partners, and trial applications are recommended due to variation between generic products.

PRECAUTIONS: Ensure that underlying surfaces are clean and that there are no gaps or cracks which might allow heat transfer. Ensure that all mastics or coatings have been allowed to cure completely and for solvents to evaporate. Underlying insulation, vapour barrier or jacketing shall be secured adequately.

If a vapour barrier or jacket is applied it shall be verified that it is capable of supporting the weight of the Arma-Chek covering. If the vapour barrier or jacketing may delaminate from the underlying insulation, consideration shall be given to the use of secured spiral wound insulation binding wire around the surface at 200mm (8 in.) centres. Metal banding is not recommended because the buckles will adversely affect the installed appearance.

SURFACE PREPARATION BEFORE APPLYING ARMA-CHEK R:

Underlying surface	Surface Preparation		
	Untreated surface	Surface sealed with reinforced liquid coating	Surface covered with foil-faced laminate
Rigid preformed PIR/ PUR (Polyisocyanurate/ Polyurethane)	Seal with ArmaFlex adhesive	Acceptable	Acceptable, spiral-wound binding wire may be required
Cellular Glass	Fill cells and seal with ArmaFlex adhesive	Acceptable	Acceptable if adhered using ArmaFlex adhesive
Mineral Wool with density $\geq 80 \text{ kg/m}^3$	Acceptable	Not applicable	Acceptable, spiral-wound binding wire may be required
Ceramic Fibre with density $\geq 80 \text{ kg/m}^3$	Acceptable	Not applicable	Acceptable, spiral-wound binding wire may be required
Nanocomposite Insulation	Unknown	Not applicable	Acceptable, spiral-wound binding wire may be required

Inspection Checklist

Continuous or frequent supervision of all application activities is recommended and as a minimum the following inspections shall be carried during every working period.

Inspection Activity – Arma-Chek R	Completed ✓
Temperature and relative humidity monitored and recorded during installation. Precautions taken if weather conditions unsuitable for application	
Arma-Chek R and underlying layers to be clean, dry and fit for purpose. Between 3 - 24 hours has elapsed since completion of application of previous insulation layers	
All circumferential and longitudinal overlaps (of minimum 50 mm) staggered and fixed down with Armaflex Adhesive as per Application Guide	
All fixing seams staggered to the side to shed water	
All seams and joints cleaned with Armaflex Cleaner before applying Arma-Chek Mastic sealant	
Arma-Chek Mastic sealant applied to all seams and joints – minimum 10 mm wide and 3 mm thick	
All unwanted adhesive has been removed	
Where applicable, damaged insulation or Arma-Chek R has been repaired / replaced	
Weather seal with Arma-Chek Mastic sealant at all cap-end terminations, including next to flanges and all welded/clamped piping supports / protrusions.	

All data and technical information are based on results achieved under the specific conditions defined according to the testing standards referenced. Despite taking every precaution to ensure that said data and technical information are up to date, Armacell does not make any representation or warranty, express or implied, as to the accuracy, content or completeness of said data and technical information. Armacell also does not assume any liability towards any person resulting from the use of said data or technical information. Armacell reserves the right to revoke, modify or amend this document at any moment. It is the customer's responsibility to verify if the product is suitable for the intended application. The responsibility for professional and correct installation and compliance with relevant building regulations lies with the customer. This document does not constitute nor is part of a legal offer to sell or to contract.

At Armacell, your trust means everything to us, so we want to let you know your rights and make it easier for you to understand what information we collect and why we collect it. If you would like to find out about our processing of your data, please visit our [Data Protection Policy](#).

© Armacell, 2023. Arma-Chek® is a trademark of the Armacell Group and is registered in the European Union and other countries.
0146 | Arma-Chek Industrial | Arma-Chek | InstManual | 012023 | Global | EN MASTER

ABOUT ARMACELL

As the inventor of flexible foam for equipment insulation and a leading provider of engineered foams, Armacell develops innovative and safe thermal and mechanical solutions that create sustainable value for its customers. Armacell's products significantly contribute to global energy efficiency making a difference around the world every day. With more than 3,300 employees and 27 production plants in 19 countries, the company operates two main businesses, Advanced Insulation and Engineered Foams. Armacell focuses on insulation materials for technical equipment, high-performance foams for acoustic and lightweight applications, recycled PET products, next-generation aerogel technology and passive fire protection systems.

For more information, please visit:
www.armacell.com/energy

